

# Spectrum Analyzer

GSP-818 Series

---

## PROGRAMMING MANUAL

GW INSTEK PART NO



ISO-9001 CERTIFIED MANUFACTURER

**GW INSTEK**

This manual contains proprietary information which is protected by copyright. All rights are reserved. No part of this manual may be photocopied, reproduced or translated to another language without prior written consent of Good Will Corporation.

The information in this manual was correct at the time of printing. However, Good Will continues to improve products and reserves the right to change specifications, equipment, and maintenance procedures at any time without notice.

# Table of Contents

<b>SAFETY INSTRUCTIONS</b> .....	<b>4</b>
<b>GETTING STARTED</b> .....	<b>8</b>
Package Contents and Accessories.....	9
Front Panel Overview .....	10
Rear Panel .....	10
Front Panel Function Key .....	14
Parameter Input.....	17
User Interface .....	19
<b>COMMAND OVERVIEW</b> .....	<b>21</b>
Command Syntax .....	21
List of Commands in Functional Order .....	24
<b>COMMAND DETAILS</b> .....	<b>30</b>
Common commands.....	31
Calculate Commands .....	32
Calibration Commands .....	47
Configure Commands .....	48
Display Commands.....	50
Hcopy Commands.....	57
Initiate Command .....	60
MMEMory Commands .....	61
Output Subsystem .....	65
Sense Commands .....	66
Source Command .....	94
System Commands .....	95
Trace Commands .....	100
Trigger Commands.....	102
UDISK Commands .....	103
UNIT Command.....	104

# S SAFETY INSTRUCTIONS

This chapter contains important safety instructions that you must follow when operating the GSP-818, and when keeping it in storage. Read the following before operating the GSP-818 to ensure your safety and to keep the GSP-818 series in the best possible condition.

## Safety Symbols

These safety symbols may appear in this manual or on the GSP-818.

---



WARNING

Warning: Identifies conditions or practices that could result in injury or loss of life.



CAUTION

Caution: Identifies conditions or practices that could result in damage to THE GSP-818 or to other properties.



DANGER High Voltage



Attention Refer to the Manual



Protective Conductor Terminal



Earth (ground) Terminal



Do not dispose electronic equipment as unsorted municipal waste. Please use a separate collection facility or contact the supplier from which this instrument was purchased.

## Safety Guidelines

---

### General Guideline



#### CAUTION

- Do not place any heavy object on the GSP-818.
- Avoid severe impact or rough handling that leads to damaging the GSP-818.
- Do not discharge static electricity to the GSP-818.
- Do not block or obstruct the cooling fan vent openings.
- Do not perform measurement at circuits directly connected to Mains (Note below).
- Do not disassemble the GSP-818 unless you are qualified as service personnel.
- The equipment is not for measurements performed for CAT II, III and IV.

(Measurement categories) EN 61010-1:2010 specifies the measurement categories and their requirements as follows. The GSP-818 falls under category I.

- Measurement category IV is for measurement performed at the source of low-voltage installation.
- Measurement category III is for measurement performed in the building installation.
- Measurement category II is for measurement performed on the circuits directly connected to the low voltage installation.
- 0 is for measurements performed on circuits not directly connected to Mains.

---

### Power Supply



#### WARNING

- AC Input voltage range: 100-120Vac/ 200-240Vac (90-132Vac/ 180-250Vac)  
Frequency: 50/60Hz
  - Connect the protective grounding conductor of the AC power cord to an earth ground, to avoid electrical shock.
-

Fuse



WARNING

- Fuse type: T3.15A/250V
  - Make sure the correct type of fuse is installed before power up.
  - To avoid fire, only replace the fuse with the specified type and rating.
  - Disconnect the power cord before fuse replacement.
  - Make sure the cause of a fuse blowout is fixed before replacing the fuse.
- 

Cleaning the  
GSP-818

- Disconnect the power cord before cleaning.
  - Use a soft cloth dampened in a solution of mild detergent and water. Do not spray any liquid.
  - Do not use chemicals or cleaners containing harsh material such as benzene, toluene, xylene, and acetone.
- 

Operation  
Environment

- Location: Indoor, no direct sunlight, dust free, almost non-conductive pollution (Note below)
- Temperature: 0°C to 40°C
- Altitude: Up to 2000m
- Transient Overvoltage on the main supply is 2500V.

(Pollution Degree) EN 61010-1:2010 specifies the pollution degrees and their requirements as follows. THE GSP-818 falls under degree 2.

Pollution refers to “addition of foreign matter, solid, liquid, or gaseous (ionized gases), that may produce a reduction of dielectric strength or surface resistivity”.

- Pollution degree 1: No pollution or only dry, non-conductive pollution occurs. The pollution has no influence.
- Pollution degree 2: Normally only non-conductive pollution occurs. Occasionally, however, a temporary conductivity caused by condensation must be expected.
- Pollution degree 3: Conductive pollution occurs, or dry, non-conductive pollution occurs which becomes conductive due to condensation which is expected. In such conditions, equipment is normally protected against exposure to direct sunlight, precipitation, and full wind pressure, but neither temperature nor humidity is controlled.

---

#### Storage environment

- Location: Indoor
- Relative Humidity: < 80%
- Temperature:  $-10^{\circ}\text{C}$  to  $70^{\circ}\text{C}$

#### Disposal



Do not dispose this instrument as unsorted municipal waste. Please use a separate collection facility or contact the supplier from which this instrument was purchased. Please make sure discarded electrical waste is properly recycled to reduce environmental impact.

# G ETTING STARTED

This chapter introduces the front / rear panel, the user interface and explains how to use the instrument with a measurement example demonstration.







---

Package Contents and Accessories .....	9
Front Panel Overview .....	10
Rear Panel .....	10
Front Panel Function Key .....	14
Parameter Input.....	17
Numeric Keypad .....	17
User Interface .....	19

## Package Contents and Accessories

The GSP-818 has a number of standard and optional accessories that can be ordered. For more information please visit the GW Instek website at [www.gwinstek.com](http://www.gwinstek.com) or consult your authorized distributor for details.

Standard Accessories	Description
Power Cable	Mains power cable (region dependent)
CD ROM	Contains GSP-818 User manual, quick start guide, programming manual and USB driver

Optional Accessories	Description
	N-N Cable
	N-SMA Cable
	SMA-SMA Cable
	SMA Adaptor
	N-SMA Adaptor
	Near Field Probe includes: Four near-field probes, N-SMA adapter, SMA-SMA cable (Frequency range: 30 MHz – 3 GHz)

## Front Panel Overview

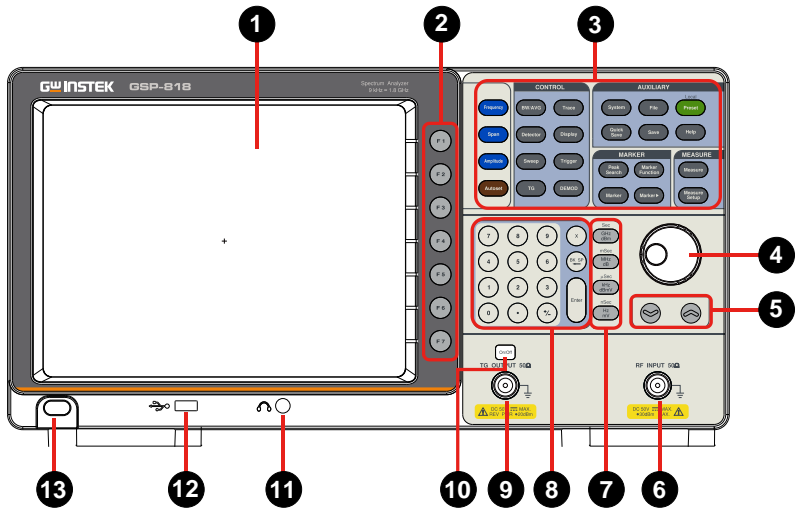

1. LCD 800x600 color LCD display. The display shows the soft keys for the current function, frequency, amplitude and marker information.
  
2. Menu soft keys The F1 to F7 function keys directly correspond to the soft keys on the right-hand side of display.



  
3. Function keys See page 14 for details.
  
4. Knob During parameter editing, turn the knob clockwise to increase, or counterclockwise to decrease the parameter values at specified steps.

  
5. Arrow keys (1) Increase or decrease the parameter value at specific steps while editing a parameter.  
(2) Move the cursor through the directory

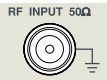

tree in the **File** function

- 
- 6. RF Input connector



The RF input may be connected to a device via a N type connector.

---

  - 

Note

When input attenuator is higher than 10 dB, the RF port input signal must be less than +30 dBm.

Input voltage at RF input port must not be higher than 50 V DC to avoid damage to the attenuator and input mixer tracking generator.

---

  - 7. Unit keys



Unit keys include GHz/dBm/s, MHz/dB/ms, kHz/dBmV/ $\mu$ s and Hz/mV/ns. After entering the desired numbers, choose an appropriate unit to complete the input. The specific meaning of unit is decided by the type of input parameter (“frequency”, “amplitude” or “time”).
  - 8. Numeric keypad

See page **錯誤! 尚未定義書籤** for details.
  - 9. TG output connector

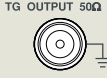

The output of the tracking generator can be connected to a receiver through an N type male connector, users can purchase this option if required.
  - 10. TG output On/Off button



When the TG function is enabled, the backlight of button turns on and turns off when the function is disabled.
  - 11. Earphone interface



3.5mm stereo headphone jack (wired for mono operation)
  - 12. USB Host port







The analyzer may serve as a "host" device to connect to external USB devices. This interface is available for USB storage devices.
  - 13. Power key

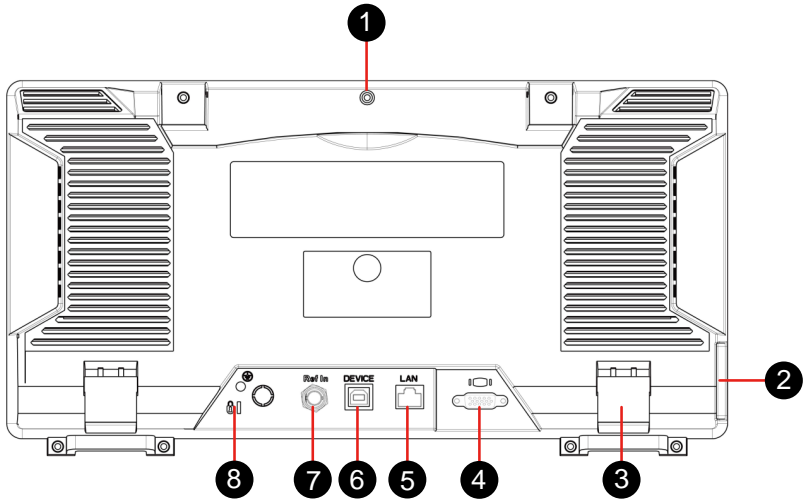

Push to turn on, long push to turn off

## Rear Panel



- |                         |   |   |
|-------------------------|---|---|
| 1. Handle               |   | Stow the handle for mobile use.   |
| 2. AC power connector   |   | AC: frequency 50Hz±10%, single-phase alternative 220V±15% or 110V±15%   |
| 3. Stool                |   | To adjust the angle of the device   |
| 4. VGA port             |   | provides a VGA signal output which is used through a VGA cable or with a projector  |
| 5. LAN interface        |  | Through this interface, the analyzer can be connected to your local network for remote control. An integrated testing system can be built quickly, as the analyzer conforms to the LXI C Device class instrument standards. |
| 6. USB Device interface |  | This configurable USB port permits external USB devices. It supports PictBridge printer and remote-control connection.  |
| 7. 10MHz IN/OUT         |  | The BNC input or output of the 10 MHz reference clock   |

**8. Lock hole**

You can lock the spectrum analyzer to a fixed location using the security lock (please buy it yourself) to secure the spectrum analyzer.

## Front Panel Function Key

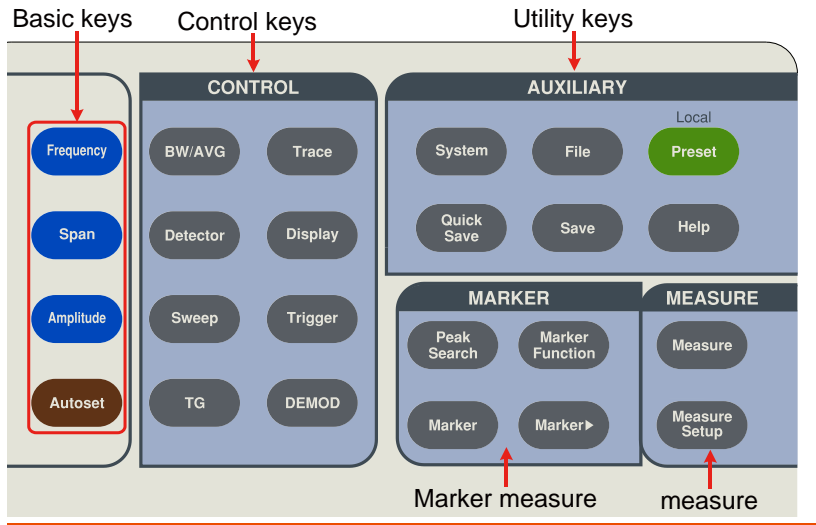

Keys	Description
<b>Basic keys</b>	
	Activates the center-frequency function, and accesses the frequency function menu.
	Activates the frequency sweep span function, and set Full Span\Zero Span\Last Span.
	Activates the reference level function, and accesses the amplitude softkeys, with which you set functions that affect data on the vertical axis.
	Searches the signal automatically within the full frequency range.

## Control keys

- BW/AVG** Activates the RBW (resolution bandwidth) function, and accesses the softkeys that control the bandwidth functions and averaging.
- Trace** Accesses the softkeys that allow you to store and manipulate trace information.
- Detector** Accesses the softkeys that allow you to configure detector functions.
- Display** Accesses the softkeys that allow you to control what is displayed on the analyzer, including the display line, graticule and label.
- Sweep** Accesses the softkeys that allow you to set the sweep time, select the sweep mode of the analyzer.
- Trigger** Accesses the softkeys that allow you to select the trigger mode of the analyzer.
- TG** Accesses the softkeys that allow you to set the tracking generator.
- DEMOD** Accesses the softkeys that allow you to set the demodulation.

## Marker measure keys

- Peak Search** Places a marker on the highest peak, and accesses the Peak functions menu.
- Marker** Accesses the marker control keys that select the type and number of markers and turns them on and off.
- Marker▶** Accesses the marker function soft keys that allow you to set other system parameters based on the current marker's value.
- Marker Function** Accesses the menu of special functions, such as noise marker, N dB bandwidth measure and frequency counting.

## Advanced measure keys

**Measure**

Accesses the softkeys that let you make transmitter power measurements such as ACPR(adjacent channel power), channel power, and OBW(occupied bandwidth), etc.

**Measure Setup**

Sets the parameters for the selected measurement function.

## Utility keys

**System**

Sets the system parameters, and accesses the calibration menu.

**File**

Accesses the softkeys that allow you to configure the file system of the analyzer.

**Preset**

Resets the analyzer to the factory settings or user state. This state can be specified in **【System】** → [PowerOn/Preset▶] →[Preset▶].

**Quick Save**

Save the contents of the current screen quickly.

**Save**

Accesses the soft keys that allow you to save current screen, trace data, or user state.

**Help**





Press the Help key to activate the help system. Press the Help key again to exit.

## Parameter Input

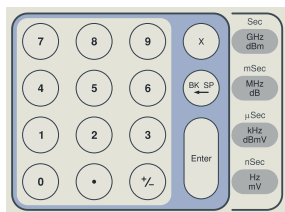
Specific parameter values are able to be entered using the numeric keypad, knob, and directional keys.

### Numeric Keypad



- Numeric keys**      Numbers 0-9 are available to be used.
- Decimal point**       A decimal point "." will be inserted at the cursor position when this key is pressed.
- Sign key**       Sign key "+/-" is to toggle the sign of a parameter. When pressed the first time, a "-" will be inserted and changed into "+" following the second press.
- Cancel key**       (1) During the editing process this key will clear the inputs in the active area and exit editing mode at the same time.  
 (2) Turn off the display in the active area.  
 (3) Exit current test mode while in keyboard test.
- Back key**       (1) During the process of parameter editing, this key will delete the characters on the left side of the cursor.  
 (2) While in the process of file name editing, pressing this key will delete characters that have been entered.

Enter key



When pressed, the system will complete the input process and insert a default measurement unit for the parameter automatically.





Unit keys



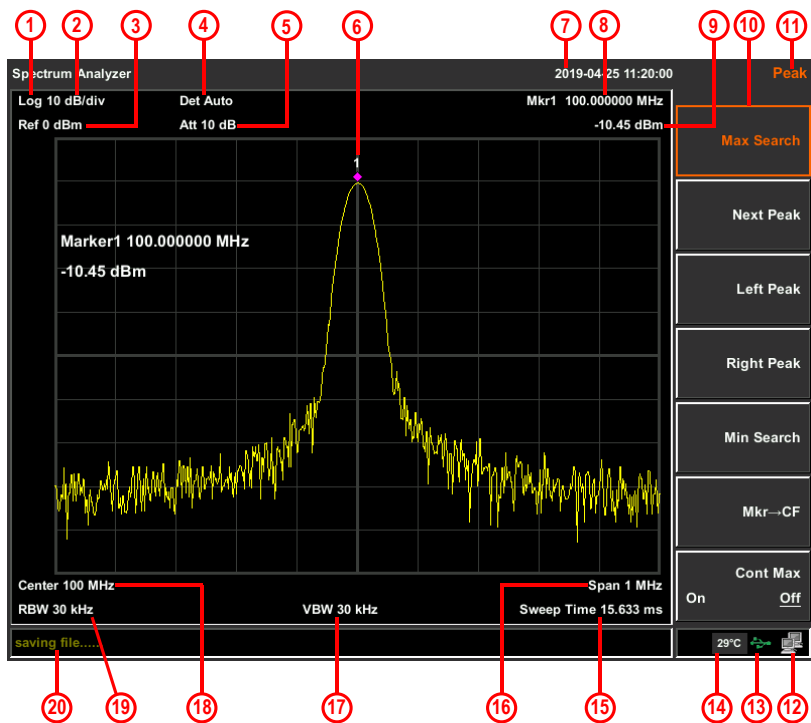







Unit keys include GHz/dBm/Sec, MHz/dB/mSec, kHz/dBmV/µSec and Hz/mV/nSec. After entering the desired numbers, choose an appropriate unit to complete the input. The specific meaning of unit is decided by the type of input parameter ("frequency", "amplitude" or "time").

## User Interface



No.	Name	Description	Related Key
1.	Amplitude Division Type	Can choose logarithmic or linear	 → [Scale Type]
2.	Amplitude Division	Display division scale	 → [Scale/Div]
3.	Reference level	Reference level	 → [Ref Level]
4.	Detection type	Display detection type	
5.	Attenuation	Display input attenuation setting	 → [Attenuation]

6.	Marker	Display current activated marker	
7.	Date/time	Display system date and time	 → [Date/Time]
8.9.	Marker readout	Display frequency and amplitude of current marker	
10.	Menu item	Menu item of current function	
11.	Menu title	Function of current menu belongs to.	
12.	LAN access sign	LAN access sign	
13.	USB storage device	Show if USB storage device is inserted;	
14.	Temperature sign	Display device internal temperature	
15.	Sweep Time	System sweep time	 → [Sweep Time]
16.	Span	Display span width	 → [Span]
17.	Video bandwidth	Display video bandwidth	 → [VBW]
18.	Center frequency	Display center frequency	 → [Center Freq]
19.	Resolution bandwidth	Display resolution bandwidth	 → [RBW]
20.	System status	Display spectrum analyzer status	

# C COMMAND OVERVIEW

The Command overview chapter lists all the GSP-818 commands and command queries. The command syntax section shows you the basic rules you have to apply when using commands.

## Command Syntax

Compatible standard	<ul style="list-style-type: none"> <li>• IEEE488.2, 1992 (fully compatible)</li> <li>• SCPI, 1994 (partially compatible)</li> </ul>
Command types	There are a number of different instrument commands and queries. A command sends instructions or data to the electronic load and a query receives data or status information from the electronic load.
<b>Command Types</b>	
Simple	A single command with/without a parameter
Example	*OPC
Compound	Two or more commands separated by a colon (:) with/without a parameter
Example	UTILITY:SOUND 1
Query	A query is a simple or compound command followed by a question mark (?). A parameter (data) is returned.
Example	UTILITY:SOUND?

Command forms    Commands and queries have two different forms, long and short. The command syntax is written with the short form of the command in capitals and the remainder (long form) in lower case.

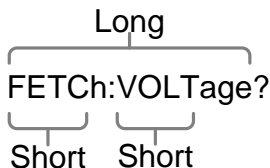

The commands can be written in capitals or lower-case, just so long as the short or long forms are complete. An incomplete command will not be recognized.

Below are examples of correctly written commands.

LONG    FETCh:VOLTage?    FETCh:VOTAGE?  
           fetch:voltage?

SHORT    FETC:VOLT?            fetc:volt?

Square Brackets    Commands that contain squares brackets indicate that the contents are optional. The function of the command is the same with or without the square bracketed items, as shown below.

Example:

```
:LOAD[:STATe]
=                    :LOAD:STATe
=                    :LOAD
```

Command format    :PROGram:CHAIin <NR1>LF

1
2
3
4

1: command header  
 2: single space  
 3: parameter  
 4: message terminator

Parameter	Type	Description	Example
	<Boolean>	Boolean logic	0, 1
	<NR1>	integers	0, 1, 2, 3
	<NR2>	decimal numbers	0.1, 3.14, 8.5
	<NR3>	floating point	4.5e-1, 8.25e+1
	<NRf>	any of NR1, 2, 3	1, 1.5, 4.5e-1
	<NRf+>	NRf type including MIN (minimum) and MAX (maximum) limits of the parameter.	1, 1.5, 4.5e-1 MAX, MIN
	<aard>	Arbitrary ascii characters.	
	<block data>	IEEE-488.2 binary block data. The block data is comprised of five parts:	
		<pre> #216&lt;16_bytes_data&gt;&lt;NL&gt;           a b c   d   e </pre>	
		<ul style="list-style-type: none"> <li>a. Initialization character (#)</li> <li>b. Digit length (in ASCII) of the number of bytes</li> <li>c. Number of bytes</li> <li>d. Binary data</li> <li>e. New line character</li> </ul>	
Message terminator	LF^END	line feed code (hexadecimal 0A) with END message	
	LF	line feed code	
	<dab>^END	last data byte with END message	

## List of Commands in Functional Order

Common	*IDN? .....	31
Commands	*RST .....	31

---

Calculate	:CALCulate:BWIDth BANDwidth:NDB .....	33
Commands	:CALCulate:BWIDth BANDwidth:RESult? .....	33
	:CALCulate:BWIDth BANDwidth[:STATe] .....	33
	:CALCulate:MARKer:AOff .....	34
	:CALCulate:MARKer<n>:CPEak[:STATe] .....	34
	:CALCulate:MARKer<n>:DELTA[:SET]:CENTer .....	35
	:CALCulate:MARKer<n>:DELTA[:SET]:SPAN .....	35
	:CALCulate:MARKer<n>:FCOut:RESolution .....	35
	:CALCulate:MARKer<n>:FCOut[:STATe] .....	36
	:CALCulate:MARKer<n>:FCOut:X? .....	36
	:CALCulate:MARKer:FUNCTion:AOff .....	37
	:CALCulate:MARKer<n>:MAXimum .....	37
	:CALCulate:MARKer<n>:MAXimum:LEFT .....	37
	:CALCulate:MARKer<n>:MAXimum:NEXT .....	37
	:CALCulate:MARKer<n>:MAXimum:RIGHT .....	39
	:CALCulate:MARKer<n>:MINimum .....	39
	:CALCulate:MARKer<n>:MODE .....	39
	:CALCulate:MARKer<n>:PHNoise[:STATe] .....	40
	:CALCulate:MARKer:PHNoise:Y? .....	40
	:CALCulate:MARKer<n>[:SET]:CENTer .....	41
	:CALCulate:MARKer<n>[:SET]:RLEVel .....	41
	:CALCulate:MARKer<n>[:SET]:STARt .....	41
	:CALCulate:MARKer<n>[:SET]:STEP .....	42
	:CALCulate:MARKer<n>[:SET]:STOP .....	42
	:CALCulate:MARKer<n>:STATe .....	42
	:CALCulate:MARKer:TABLE:STATe .....	43
	:CALCulate:MARKer<n>:TRACe .....	43
	:CALCulate:MARKer<n>:DELTA:X? .....	44
	:CALCulate:MARKer<n>:DELTA:Y? .....	44

---

	:CALCulate:MARKer<n>:X .....	44
	:CALCulate:MARKer<n>:Y? .....	45
	:CALCulate:NETMeasure:POWer .....	45
	:CALCulate:NTDate:NORMalize .....	46
	:CALCulate:TUNE:AUTO .....	46

---

Calculate	:CALibration[:ALL] .....	47
Commands	:CALibration:RESTore .....	47

---

Configure	:CONFigure:ACPower .....	48
Commands	:CONFigure:CHPower .....	48
	:CONFigure:OBWidth .....	48
	:CONFigure:SANalyzer .....	49
	:CONFigure:SATime .....	49

---

Display	:DISPlay:ANNotation:CLOCK:DATE:FORMat.....	50
Commands	:DISPlay:ANNotation:CLOCK[:STATe] .....	51
	:DISPlay:FORMat:ZOOM .....	51
	:DISPlay:MENU:STATe.....	52
	:DISPlay:WINDow:GRID .....	52
	:DISPlay:WINDow:LABEL.....	53
	:DISPlay:WINDow:TRACe:X[:SCALe]:OFFSet .....	53
	:DISPlay:WINDow:TRACe:Y:DLINe .....	53
	:DISPlay:WINDow:TRACe:Y:DLINe:STATe.....	54
	:DISPlay:WINDow:TRACe:Y[:SCALe]:GAUge.....	54
	:DISPlay:WINDow:TRACe:Y[:SCALe]:PDIVision .....	55
	:DISPlay:WINDow:TRACe:Y[:SCALe]:RLEVel .....	55
	:DISPlay:WINDow:TRACe:Y[:SCALe]:RLEVel :OFFSet56	
	:DISPlay:WINDow:TRACe:Y[:SCALe]:SPACing .....	56

---

HCOPY	:HCOPY:IMAGe:COLor[:STATe] .....	57
Commands	:HCOPY:IMAGe:TYPe .....	57
	:HCOPY:PAGE:ORientation.....	58
	:HCOPY:PAGE:PRINts .....	58
	:HCOPY:PAGE:SIZE .....	58

---

---

	:HCOpy:SCReen.....	59
	:HCOpy:TRACe .....	59

---

Initiate Command	[:INITiate]:CONTInuous .....	60
------------------	------------------------------	----

---

MMEemory Commands	:MMEMory:CATalog? .....	61
	:MMEMory:COpy:SCReen .....	61
	:MMEMory:COpy:TRACe .....	62
	:MMEMory:DELeTe:ALL.....	62
	:MMEMory:DELeTe:SCReen .....	62
	:MMEMory:DELeTe:SCReen:ALL .....	62
	:MMEMory:DELeTe:TRACe .....	62
	:MMEMory:DELeTe:TRACe:ALL.....	63
	:MMEMory:DISK:INFormation .....	63
	:MMEMory:LOAD:SCReen .....	63
	:MMEMory:LOAD:TRACe.....	63
	:MMEMory:STORE:QUICK:SAVE .....	64
	:MMEMory:STORE:SCReen.....	64
	:MMEMory:STORE:STATe .....	64
	:MMEMory:STORE:TRACe .....	64

---

Output Command	:OUTPut:TRACk[:STATe].....	65
----------------	----------------------------	----

---

Sense Commands	[:SENSe]:ACPower:BANDwidth:ACHannel:COUNT..	68
	[:SENSe]:ACPower:BANDwidth:INTEgration .....	68
	[:SENSe]:ACPower:CSPacing .....	68
	[:SENSe]:AVERAge:COUNT .....	69
	[:SENSe]:AVERAge[:STATe] .....	69
	[:SENSe]:BANDwidth BWIDth[:RESolution] .....	69
	[:SENSe]:BANDwidth BWIDth[:RESolution]:AUTO ..	70
	[:SENSe]:BANDwidth BWIDth[:RESolution]:STEP	
	:MODE .....	70
	[:SENSe]:BANDwidth BWIDth:VIDeo .....	71
	[:SENSe]:BANDwidth BWIDth:VIDeo:AUTO .....	71
	[:SENSe]:BANDwidth:EMC.....	72

[:SENSe]:BANDwidth:EMC:STATe .....	72
[:SENSe]:DEMod:AM[:CARRier]:FREQuency .....	73
[:SENSe]:DEMod:AM:IFBW .....	73
[:SENSe]:DEMod:AM:IFBW:AUTO .....	73
[:SENSe]:DEMod:AM:STATe .....	74
[:SENSe]:DEMod:FM[:CARRier]:FREQuency .....	74
[:SENSe]:DEMod:FM:IFBW .....	75
[:SENSe]:DEMod:FM:IFBW:AUTO .....	75
[:SENSe]:DEMod:FM:STATe .....	76
[:SENSe]:DEMod:FREQuency.....	76
[:SENSe]:DEMod:MODE .....	76
[:SENSe]:DEMod:STATe .....	77
[:SENSe]:DETEctor[:FUNCTion] .....	77
[:SENSe]:FREQuency:CENTer .....	78
[:SENSe]:FREQuency:CENTer:STEP:AUTO .....	78
[:SENSe]:FREQuency:CENTer:STEP[:INCRement] ...	79
[:SENSe]:FREQuency:REFerence .....	79
[:SENSe]:FREQuency:SPAN.....	79
[:SENSe]:FREQuency:SPAN:FULL.....	80
[:SENSe]:FREQuency:SPAN:PREVious.....	80
[:SENSe]:FREQuency:SPAN:ZERO .....	80
[:SENSe]:FREQuency:STARt .....	80
[:SENSe]:FREQuency:STOP.....	81
[:SENSe]:OBWidth:PERCent.....	81
[:SENSe]:PASSFAIL:LINELimit:LOWer:CLEar .....	81
[:SENSe]:PASSFAIL:LINELimit:LOWer:POINT<n> :DELete.....	81
[:SENSe]:PASSFAIL:LINELimit:LOWer:POINT<n>:X	82
[:SENSe]:PASSFAIL:LINELimit:LOWer:POINT<n>:Y	82
[:SENSe]:PASSFAIL:LINELimit:LOWer:STATe .....	83
[:SENSe]:PASSFAIL:LINELimit:MARK<n>:STATe? ...	83
[:SENSe]:PASSFAIL:LINELimit:STATe.....	83
[:SENSe]:PASSFAIL:LINELimit:UPper:CLEar .....	84
[:SENSe]:PASSFAIL:LINELimit:UPper:POINT<n> :DELete.....	84

	[:SENSe]:PASSFAIL:LINELimit:Upper:POINt<n>:X..	84
	[:SENSe]:PASSFAIL:LINELimit:Upper:POINt<n>:Y..	85
	[:SENSe]:PASSFAIL:LINELimit:UPPer:STATe .....	85
	[:SENSe]:PASSFAIL:LINELimit:X:OFFSET .....	86
	[:SENSe]:PASSFAIL:LINELimit:Y:OFFSET .....	86
	[:SENSe]:PASSFAIL:WINDow:AMPL:LOWer .....	86
	[:SENSe]:PASSFAIL:WINDow:AMPL:UPper .....	87
	[:SENSe]:PASSFAIL:WINDow:AMPt:STATe .....	87
	[:SENSe]:PASSFAIL:WINDow:FREQuency:END .....	88
	[:SENSe]:PASSFAIL:WINDow:FREQuency:STARt .....	88
	[:SENSe]:PASSFAIL:WINDow:FREQuency:STATe .....	88
	[:SENSe]:PASSFAIL:WINDow:MARK<n> :STATe? .....	89
	[:SENSe]:PASSFAIL:WINDow:STATe .....	89
	[:SENSe]:PASSFAIL:WINDow:SWEEP:STATe .....	90
	[:SENSe]:POWER[:RF]:ATTenuation .....	90
	[:SENSe]:POWER[:RF]:ATTenuation:AUTO .....	91
	[:SENSe]:POWER[:RF]:ATTenuation:AUTO .....	91
	[:SENSe]:SWEep:POINts .....	92
	[:SENSe]:SWEep:TIME .....	92
	[:SENSe]:SWEep:TIME:AUTO .....	92
<hr/>		
Source Command	:SOURce:POWER:TRACk[:POWER] .....	94
<hr/>		
System	:SYSTem:COMMunicate:LAN:DHCP .....	95
Commands	:SYSTem:COMMunicate:LAN:GATE .....	95
	:SYSTem:COMMunicate:LAN:IP:ADDRes .....	96
	:SYSTem:COMMunicate:LAN:MASK .....	96
	:SYSTem:CONFigure:FIRMwareupdate .....	96
	:SYSTem:CONFigure:information? .....	97
	:SYSTem:DATE .....	97
	:SYSTem:LANGuage .....	97
	:SYSTem:PON:TYPE .....	98
	:SYSTem:PRESet:TYPE .....	98
	:SYSTem:SPEaker:VOLume .....	98
	:SYSTem:Time .....	99

Trace Commands :TRACe[:DATA]? ..... 100

---

Trigger :TRIGger:SEQuence:SOURce ..... 102

Commands :TRIGger:SEQuence:SOURce:VIDeo:POWer ..... 102

---

UDisk :UDISk:STORe:SCReen ..... 103

Commands :UDISk:STORe:TRACe ..... 103

---

Unit Command :UNIT:POWer ..... 104

---

# C COMMAND DETAILS

The Command details chapter shows the detailed syntax, equivalent panel operation, and example for each command. For the list of all commands, see page 24.

---

Common commands .....	31
Calculate Commands .....	32
Calibration Commands .....	47
Configure Commands .....	48
Display Commands .....	50
Hcopy Commands .....	57
Initiate Command .....	60
MMEMory Commands .....	61
Output Subsystem .....	65
Sense Commands .....	66
Source Command .....	94
System Commands .....	95
Trace Commands .....	100

## Common commands

*IDN? .....	31
*RST .....	31

### \*IDN?

→ Query

Description	Queries the manufacturer, model number, serial number and firmware version of the instrument.
Query Syntax	*IDN?
Comment	<p>&lt;String&gt; Returns the instrument identification as a string in the following format:</p> <p>GWINSTEK, GSP-818, GSPXXXXXX, VX.X.X</p> <p>Manufacturer: GWINSTEK</p> <p>Model number: GSP-818</p> <p>Serial number: GSPXXXXXX</p> <p>Firmware version: VX.X.X</p>

### \*RST

Set →

Description	Reset the instrument to a factory defined condition
Syntax	*RST
Example	*RST

## Calculate Commands

:CALCulate:BWIDth BANDwidth:NDB .....	33
:CALCulate:BWIDth BANDwidth:RESult? .....	33
:CALCulate:BWIDth BANDwidth[:STATe] .....	33
:CALCulate:MARKer:AOff .....	34
:CALCulate:MARKer<n>:CPEak[:STATe] .....	34
:CALCulate:MARKer<n>:DELTA[:SET]:CENTer .....	35
:CALCulate:MARKer<n>:DELTA[:SET]:SPAN .....	35
:CALCulate:MARKer<n>:FCOunt:RESolution .....	35
:CALCulate:MARKer<n>:FCOunt[:STATe].....	36
:CALCulate:MARKer<n>:FCOunt:X? .....	36
:CALCulate:MARKer:FUNCTion:AOff .....	37
:CALCulate:MARKer<n>:MAXimum .....	37
:CALCulate:MARKer<n>:MAXimum:LEFT .....	37
:CALCulate:MARKer<n>:MAXimum:NEXT.....	37
:CALCulate:MARKer<n>:MAXimum:RIGHT.....	39
:CALCulate:MARKer<n>:MINimum.....	39
:CALCulate:MARKer<n>:MODE.....	39
:CALCulate:MARKer<n>:PHNoise[:STATe].....	40
:CALCulate:MARKer:PHNoise:Y? .....	40
:CALCulate:MARKer<n>[:SET]:CENTer .....	41
:CALCulate:MARKer<n>[:SET]:RLEVel .....	41
:CALCulate:MARKer<n>[:SET]:STARt.....	41
:CALCulate:MARKer<n>[:SET]:STEP .....	42
:CALCulate:MARKer<n>[:SET]:STOP .....	42
:CALCulate:MARKer<n>:STATe.....	42
:CALCulate:MARKer:TABLE:STATe .....	43
:CALCulate:MARKer<n>:TRACe .....	43
:CALCulate:MARKer<n>:DELTA:X? .....	44
:CALCulate:MARKer<n>:DELTA:Y? .....	44
:CALCulate:MARKer<n>:X .....	44
:CALCulate:MARKer<n>:Y? .....	45
:CALCulate:NETMeasure:POWer .....	45

:CALCulate:NTDate:NORMALize .....46

:CALCulate:TUNE:AUTO .....46

Set →  
 → Query

**:CALCulate:BWIDth|BANDwidth:NDB**

Description	Sets the power level, below the peak of the signal, at which the signal bandwidth will be measured by the markers. :CALCulate:BWIDth BANDwidth[:STATe] must be ON.
Syntax	:CALCulate:BWIDth BANDwidth:NDB <rel_amp>
Query Syntax	:CALCulate:BWIDth BANDwidth:NDB?
Parameter	<rel_amp> <NR2>1dB to 60dB
Return parameter	<NR3>
Example	:CALC:BAND:NDB 5

→ Query

**:CALCulate:BWIDth|BANDwidth:RESult?**

Description	Returns the NdB bandwidth measurement.
Query Syntax	:CALCulate:BWIDth BANDwidth:RESult?
Return parameter	<NR1> NdB bandwidth in Hz.
Example	:CALC:BAND:RES? >26000

Set →  
 → Query

**:CALCulate:BWIDth|BANDwidth[:STATe]**

Description	Sets or queries the state of the NdB bandwidth measurement function. The function measures the bandwidth, at the number of dB down specified in :CALCulate:BWIDth BANDwidth:NDB, of the maximum signal on the display.
-------------	--

Syntax	:CALCulate:BWIDth BANDwidth[:STATe]	
Query Syntax	{OFF ON 0 1}	
	:CALCulate:BWIDth BANDwidth[:STATe]?	
Parameter	0	Turns NdB BW off.
	1	Turns NdB BW on.
	OFF	Turns NdB BW off.
	ON	Turns NdB BW on.
Return parameter	0	NdB BW is off.
	1	NdB BW is on.
Example	:CALC:BAND ON	

:CALCulate:MARKer:AOff Set →

Description	Turns all the markers off.	
Syntax	:CALCulate:MARKer:AOff	
Example	:CALC:MARK:AOff	

:CALCulate:MARKer<n>:CPEak[:STATe] Set →  
→ Query

Description	Sets or queries the state of continuous peaking. It continuously puts the selected marker on the highest displayed signal peak. This function is intended to maintain the marker on signals with a frequency that is changing, and an amplitude that is not changing.	
Syntax	:CALCulate:MARKer<n>:CPEak[:STATe] {OFF ON 0 1}	
Query Syntax	:CALCulate:MARKer<n>:CPEak[:STATe]?	
Parameter	<n>	<NR1>Marker number 1 to 5
	0	Turns continuous peaking off.
	1	Turns continuous peaking on.
	OFF	Turns continuous peaking off.
	ON	Turns continuous peaking on.

Return parameter	0	Continuous peaking is off.
	1	Continuous peaking is on.

Example :CALC:MARK1:CPE ON

**:CALCulate:MARKer<n>:DELTA[:SET]:CENTer** (Set) →

**Description** Changes the center frequency of the analyzer to the frequency difference between the two markers. This command is not available if the delta marker is off.

**Syntax** :CALCulate:MARKer<n>:DELTA[:SET]:CENTer

**Parameter** <n> <NR1>Marker number 1 to 5

Example :CALC:MARK1:DELT:CENT

**:CALCulate:MARKer<n>:DELTA[:SET]:SPAN** (Set) →

**Description** Changes the span of the analyzer to the frequency difference between the two markers. This command is not available if the delta marker is off.

**Syntax** :CALCulate:MARKer<n>:DELTA[:SET]:SPAN

**Parameter** <n> <NR1> Marker number 1 to 5

Example :CALC:MARK1:DELT:SPAN

**:CALCulate:MARKer<n>:FCOunt:RESolution** (Set) →  
→ (Query)

**Description** Sets or queries the frequency counter resolution in Hz for the specified marker.

**Syntax** :CALCulate:MARKer<n>:FCOunt:RESolution <freq>

**Query Syntax** :CALCulate:MARKer<n>:FCOunt:RESolution?

**Parameter** <n> <NR1> Marker number 1 to 5.  
 Only one marker can be selected at a time to use the marker counter

		function. The selected marker counter will disable the previously selected marker counter.
	<freq>	Frequency resolution in Hz. Only 1000, 100, 10, 1 Hz are meaningful.
Return parameter	<freq>	Frequency resolution in Hz
Example	:CALC:MARK1:FCO:RES 1	

:CALCulate:MARKer<n>:FCOunt[:STATe] 
 →  
 →

Description	Sets or queries the state of the marker frequency counter function.	
Syntax	:CALCulate:MARKer<n>:FCOunt[:STATe] {OFF ON 0 1}	
Query Syntax	:CALCulate:MARKer<n>:FCOunt[:STATe]?	
Parameter	<n>	<NR1> Marker number 1 to 5.
	0	Turns frequency counter off.
	1	Turns frequency counter on.
	OFF	Turns frequency counter off.
	ON	Turns frequency counter on.
Return parameter	0	Frequency counter is off.
	1	Frequency counter is on.
Example	:CALC:MARKer1:FCO 1	

:CALCulate:MARKer<n>:FCOunt:X? →

Description	Returns the counter frequency of the selected marker in Hz.	
Query Syntax	:CALCulate:MARKer<n>:FCOunt:X?	
Parameter	<n>	<NR1> Marker number 1 to 5.
Return parameter	<freq>	<NR1> Frequency in Hz.

Example :CALC:MARK1:FCO:X?  
>230580000

**:CALCulate:MARKer:FUNction:AOff** Set →

Description Turns off the opened noise markers or NdB BW measurements, but not the markers themselves.

Syntax :CALCulate:MARKer:FUNction:AOff

Example :CALC:MARK:FUNC:AOff

**:CALCulate:MARKer<n>:MAXimum** Set →

Description Performs peak search and places a marker on the highest peak.

Syntax :CALCulate:MARKer<n>:MAXimum

Parameter <n> <NR1> Marker number 1 to 5

Example :CALC:MARK1:MAX

**:CALCulate:MARKer<n>:MAXimum:LEFT** Set →

Description Places the selected marker on the next highest signal peak to the left of the current marked peak.

Syntax :CALCulate:MARKer<n>:MAXimum:LEFT

Parameter <n> <NR1> Marker number 1 to 5

Example :CALC:MARK1:MAX:LEFT

**:CALCulate:MARKer<n>:MAXimum:NEXT** Set →

Description Places the selected marker on the next highest signal peak from the current marked peak.

Syntax :CALCulate:MARKer<n>:MAXimum:NEXT

Parameter <n> <NR1> Marker number 1 to 5

Example           :CALC:MARK1:MAX:NEXT

**:CALCulate:MARKer<n>:MAXimum:RIGHt** (Set) →

Description Places the selected marker on the next highest signal peak to the right of the current marked peak.

Syntax :CALCulate:MARKer<n>:MAXimum:RIGHt

Parameter <n> <NR1> Marker number 1 to 5

Example :CALC:MARK1:MAX:RIGH

**:CALCulate:MARKer<n>:MINimum** (Set) →

Description Places the selected marker on the lowest point on the trace that is assigned to that particular marker number.

Syntax :CALCulate:MARKer<n>:MINimum

Parameter <n> <NR1> Marker number 1 to 5

Example :CALC:MARK1:MIN

**:CALCulate:MARKer<n>:MODE** (Set) →  
→ (Query)

Description Sets or queries the marker type.

Syntax :CALCulate:MARKer<n>:MODE {NORMal|DELTA}

Query Syntax :CALCulate:MARKer<n>:MODE?

Parameter <n> <NR1> Marker number 1 to 5.

Return parameter <NORMal> Normal marker  
<DELTA> Delta marker

Example :CALC:MARK1:MODE NORM

**:CALCulate:MARKer<n>:PHNoise[:STATe]** → Set → Query

Description	Sets or queries the state of the Marker Noise function for the specified marker. This function measures the average noise level at the marked point and then normalize this value to 1 Hz bandwidth.	
Syntax	:CALCulate:MARKer<n>:PHNoise[:STATe] {OFF ON 0 1}	
Query Syntax	:CALCulate:MARKer<n>:PHNoise[:STATe]?	
Parameter	<n> 0 1 OFF ON	<NR1> Marker number 1 to 5. Turns Marker Noise off. Turns Marker Noise on. Turns Marker Noise off. Turns Marker Noise on.
Return parameter	0 1	Marker Noise is off. Marker Noise is on.
Example	:CALC:MARK1:PHN ON	

**:CALCulate:MARKer:PHNoise:Y?** → Query

Description	Returns the normalized noise level over a BW of 1Hz from the marker position.	
Query Syntax	:CALCulate:MARKer:PHNoise:Y?	
Return parameter	<NR2>	Normalized noise level in dBm.
Example	:CALC:MARK:PHN:Y? >127.8	

**:CALCulate:MARKer<n>[:SET]:CENTer** (Set) →

**Description**            Sets the center frequency equal to the specified marker frequency, which moves the marker to the center of the screen. In delta marker mode, the center frequency is set to the delta marker frequency. This command is not available in zero span.

**Syntax**                    :CALCulate:MARKer<n>[:SET]:CENTer

**Parameter**            <n>            <NR1> Marker number 1 to 5

**Example**                    :CALC:MARK1:CENT

**:CALCulate:MARKer<n>[:SET]:RLEVel** (Set) →

**Description**            Sets the reference level to the specified marker amplitude. In delta marker mode, the reference level is set to the delta marker amplitude.

**Syntax**                    :CALCulate:MARKer<n>[:SET]:RLEVel

**Parameter**            <n>            <NR1> Marker number 1 to 5

**Example**                    :CALC:MARK1:RLEV

**:CALCulate:MARKer<n>[:SET]:STARt** (Set) →

**Description**            Sets the start frequency to the value of the specified marker frequency. In delta marker mode, the start frequency is set to the delta marker frequency. This command is not available in zero span.

**Syntax**                    :CALCulate:MARKer<n>[:SET]:STARt

**Parameter**            <n>            <NR1> Marker number 1 to 5

**Example**                    :CALC:MARK1:STAR

**:CALCulate:MARKer<n>[:SET]:STEP (Set) →**

**Description** Sets the center frequency step size equal to the specified marker frequency. In delta marker mode, the center frequency step size is set to the delta marker frequency. This command is not available in zero span.

**Syntax** :CALCulate:MARKer<n>[:SET]:STEP

**Parameter** <n> <NR1> Marker number 1 to 5

**Example** :CALC:MARK1:STEP

**:CALCulate:MARKer<n>[:SET]:STOP (Set) →**

**Description** Sets the stop frequency to the value of the specified marker frequency. In delta marker mode, the stop frequency is set to the delta marker frequency. This command is not available in zero span.

**Syntax** :CALCulate:MARKer<n>[:SET]:STOP

**Parameter** <n> <NR1> Marker number 1 to 5

**Example** :CALC:MARK1:STOP

**:CALCulate:MARKer<n>:STATE (Set) →  
→ (Query)**

**Description** Sets or queries the state of the selected marker.

**Syntax** :CALCulate:MARKer<n>:STATE {OFF|ON|0|1}

**Query Syntax** :CALCulate:MARKer<n>:STATE?

<b>Parameter</b>	<n>	<NR1> Marker number 1 to 5.
	0	Turns the selected marker off.
	1	Turns the selected marker on.
	OFF	Turns the selected marker off.
	ON	Turns the selected marker on.

Return parameter	0	The selected marker is off.
	1	The selected marker is on.

Example :CALC:MARK1:STAT ON

Set →  
 → Query

**:CALCulate:MARKer:TABLE:STATe**

Description Sets or queries the state of the marker table.

Syntax :CALCulate:MARKer:TABLE:STATe {OFF|ON|0|1}

Query Syntax :CALCulate:MARKer:TABLE:STATe?

Parameter	0	Turns the table off.
	1	Turns the table on.
	OFF	Turns the table off.
	ON	Turns the table on.

Return parameter	0	The table is off.
	1	The table is on.

Example :CALC:MARK:TABL:STAT ON

Set →  
 → Query

**:CALCulate:MARKer<n>:TRACe**

Description Sets or queries the state of continuous peaking. It continuously puts the selected marker on the highest displayed signal peak. This function is intended to maintain the marker on signals with a frequency that is changing, and an amplitude that is not changing.

Syntax :CALCulate:MARKer<n>:TRACe <integer>

Query Syntax :CALCulate:MARKer<n>:TRACe?

Parameter/	<n>	<NR1> Marker number 1 to 5
Return parameter	<integer>	The number of the trace: (1, 2, 3, 4, 5)

Example :CALC:MARK1:TRAC 2

**:CALCulate:MARKer<n>:DELTA:X?** → Query

**Description** Returns the reference marker position of delta marker.

**Query Syntax** :CALCulate:MARKer<n>:DELTA:X?

<b>Parameter/Return parameter</b>	<n>	<NR1> Marker number 1 to 5
	<freq>	Frequency in Hz.

**Example** :CALC:MARK3:DELTA:X?  
>300000000Hz

**:CALCulate:MARKer<n>:DELTA:Y?** → Query

**Description** Returns the reference marker's vertical position of delta marker.

**Query Syntax** :CALCulate:MARKer<n>:DELTA:Y?

<b>Parameter/Return parameter</b>	<n>	<NR1> Marker number 1 to 5
	<ampl>	Power or voltage. If the specified marker is not active, returns ERR.

**Example** :CALC:MARK3:DELTA:Y?  
>9.8dBm

**:CALCulate:MARKer<n>:X** Set →  
→ Query

**Description** Sets or returns the marker position.

**Syntax** :CALCulate:MARKer<n>:X <freq>

**Query Syntax** :CALCulate:MARKer<n>:X?

<b>Parameter</b>	<n>	<NR1> Marker number 1 to 5
	<freq>	Frequency in GHz, MHz, kHz, Hz. The default unit is Hz.

Return parameter	<code>&lt;freq&gt;</code>	Frequency in Hz. If the specified marker is not active, returns ERR.
------------------	---------------------------	---

Example	<code>:CALC:MARK2:X 300MHz</code>
---------	-----------------------------------

Query Example	<code>:CALC:MARK2:X?</code> <code>&gt;300000000Hz</code>
---------------	---

**`:CALCulate:MARKer<n>:Y?` → Query**

Description	Returns the marker's vertical position.
-------------	---

Query Syntax	<code>:CALCulate:MARKer&lt;n&gt;:Y?</code>
--------------	--

Return parameter	<code>&lt;n&gt;</code>	<code>&lt;NR1&gt;</code> Marker number 1 to 5
	<code>&lt;ampl&gt;</code>	Power or voltage. If the specified marker is not active, returns ERR.

Query Example	<code>:CALC:MARK3:Y?</code> <code>&gt;9.8dBm</code>
---------------	--

Set →

**`:CALCulate:NETMeasure:POWer` → Query**

Description	Sets or queries the network measurement output power level.
-------------	---

Syntax	<code>:CALCulate:NETMeasure:POWer &lt;ampl&gt;</code>
--------	---

Query Syntax	<code>:CALCulate:NETMeasure:POWer?</code>
--------------	---

Parameter	<code>&lt;ampl&gt;</code>	<code>&lt;NRf&gt;</code> Power or voltage, -30dBm to 0dbm
-----------	---------------------------	---

Return parameter	<code>&lt;NR2&gt;</code>
------------------	--------------------------

Example	<code>:CALC:NETM:POW -10</code>
---------	---------------------------------

**:CALCulate:NTDate:NORMalize** (Set) →  
→ (Query)

Description	Turns the tracking generator normalization on/off or queries its state.	
Syntax	:CALCulate:NTDate:NORMalize {OFF ON 0 1}	
Query Syntax	:CALCulate:NTDate:NORMalize?	
Parameter	0	Turns the normalization off.
	1	Turns the normalization on.
	OFF	Turns the normalization off.
	ON	Turns the normalization on.
Return parameter	0	The normalization is off.
	1	The normalization is on.
Example	:CALC:NTD:NORM ON	

**:CALCulate:TUNE:AUTO** (Set) →

Description	Runs the auto tune function.
Description	:CALCulate:TUNE:AUTO
Syntax	:CALC:TUNE:AUTO

## Calibration Commands

:CALibration[:ALL].....	47
:CALibration:REStore.....	47

### :CALibration[:ALL]

Set →

→ Query

Description	After connecting the calibration signal to front panel <b>RF Input</b> connector, execute :CAL to perform the calibration.
Syntax	:CALibration[:ALL]
Query Syntax	:CALibration[:ALL]?
Return parameter	1 The calibration is successful.
Example	:CAL

### :CALibration:REStore

Set →

Description	Restores the calibration settings originally set at the factory.
Syntax	:CALibration:REStore
Example	:CAL:REST

## Configure Commands

:CONFigure:ACPower .....	48
:CONFigure:CHPower .....	48
:CONFigure:OBWidth .....	48
:CONFigure:SANalyzer.....	49
:CONFigure:SATime .....	49

### :CONFigure:ACPower Set →

Description	This command places the analyzer in Adjacent Channel Power measurement state.
Syntax	:CONFigure:ACPower
Example	:CONF:ACP

### :CONFigure:CHPower Set →

Description	This command places the analyzer in Channel Power measurement state.
Syntax	:CONFigure:CHPower
Example	:CONF:CHP

### :CONFigure:OBWidth Set →

Description	This command places the analyzer in Occupied Bandwidth measurement state.
Syntax	:CONFigure:OBWidth
Example	:CONF:OBW

**:CONFigure:SANalyzer**

**Set** →

Description      Directly exit the currently running measurement function.

Syntax             :CONFigure:SANalyzer

Example            :CONF:SAN

**:CONFigure:SATime**

**Set** →

Description      Turns on or off time spectrum measure mode

Syntax             :CONFigure:SATime

Example            :CONF:SAT

## Display Commands

:DISPlay:ANNotation:CLOCK:DATE:FORMat ..... 50  
 :DISPlay:ANNotation:CLOCK[:STATe] ..... 51  
 :DISPlay:FORMat:ZOOM ..... 51  
 :DISPlay:MENU:STATe ..... 52  
 :DISPlay:WINDow:GRID ..... 52  
 :DISPlay:WINDow:LABEL ..... 53  
 :DISPlay:WINDow:TRACe:X[:SCALe]:OFFSet ..... 53  
 :DISPlay:WINDow:TRACe:Y:DLINE ..... 53  
 :DISPlay:WINDow:TRACe:Y:DLINE:STATe ..... 54  
 :DISPlay:WINDow:TRACe:Y[:SCALe]:GAUge ..... 54  
 :DISPlay:WINDow:TRACe:Y[:SCALe]:PDIVision ..... 55  
 :DISPlay:WINDow:TRACe:Y[:SCALe]:RLEVEL ..... 55  
 :DISPlay:WINDow:TRACe:Y[:SCALe]:RLEVEL  
 :OFFSet ..... 56  
 :DISPlay:WINDow:TRACe:Y[:SCALe]:SPACing ..... 56

:DISPlay:ANNotation:CLOCK:DATE:FORMat  

Description	Sets or queries the display format of date & time.	
Syntax	:DISPlay:ANNotation:CLOCK:DATE:FORMat {YMDhms HMSymd}	
Query Syntax	:DISPlay:ANNotation:CLOCK:DATE:FORMat?	
Parameter/	YMDhms	Set the display format of date&time to YYYY-MM-DD HH:MM:SS.
Return parameter	HMSymd	Set the display format of date&time to HH:MM:SS YYYY-MM-DD.
Example	:DISP:ANN:CLOC:DATE:FORM YMDhms	

Set →  
 → Query

**:DISPlay:ANNotation:CLOCK[:STATe]**

**Description** Turns the on-screen date&time display on/off or queries its state.

**Syntax** :DISPlay:ANNotation:CLOCK[:STATe] {OFF|ON|0|1}

**Query Syntax** :DISPlay:ANNotation:CLOCK[:STATe]?

<b>Parameter</b>	0	Turns the date & time display off.
	1	Turns the date & time display on.
	OFF	Turns the date & time display off.
	ON	Turns the date & time display on.

<b>Return parameter</b>	0	The date & time display is off.
	1	The date & time display is on.

**Example** :DISP:ANN:CLOC ON

Set →  
 → Query

**:DISPlay:FORMat:ZOOM**

**Description** Turns the zoom-in window on/off or queries its state. The zoomed window centers on the center frequency, and its span is 1/10 of the previous span.

**Syntax** :DISPlay:FORMat:ZOOM {OFF|ON|0|1}

**Query Syntax** :DISPlay:FORMat:ZOOM?

<b>Parameter</b>	0	Turns the zoom-in window off.
	1	Turns the zoom-in window on.
	OFF	Turns the zoom-in window off.
	ON	Turns the zoom-in window on.

<b>Return parameter</b>	0	The zoom-in window is off.
	1	The zoom-in window is on.

**Example** :DISP:FORM:ZOOM ON

Set →  
 → Query

**:DISPlay:MENU:STATe**

Description	Turns the full screen display mode on/off or queries its state.	
Syntax	:DISPlay:MENU:STATe {OFF ON 0 1}	
Query Syntax	:DISPlay:MENU:STATe?	
Parameter	0	Turns the full screen display mode off.
	1	Turns the full screen display mode on.
	OFF	Turns the full screen display mode off.
	ON	Turns the full screen display mode on.
Return parameter	0	The full screen display mode is off.
	1	The full screen display mode is on.
Example	:DISP:MENU:STAT ON	

Set →  
 → Query

**:DISPlay:WINDow:GRID**

Description	Turns the on-screen grid on/off or queries its state.	
Syntax	:DISPlay:WINDow:GRID {OFF ON 0 1}	
Query Syntax	:DISPlay:WINDow:GRID?	
Parameter	0	Turns the grid off.
	1	Turns the grid on.
	OFF	Turns the grid off.
	ON	Turns the grid on.
Return parameter	0	The grid is off.
	1	The grid is on.
Example	:DISP:WIN:GRID ON	

Set →  
 → Query

**:DISPlay:WINDow:LABEL**

Description	Turns the on-screen label on/off or queries its state.	
Syntax	:DISPlay:WINDow:LABEL {OFF ON 0 1}	
Query Syntax	:DISPlay:WINDow:LABEL?	
Parameter	0	Turns the label off.
	1	Turns the label on.
	OFF	Turns the label off.
	ON	Turns the label on.
Return parameter	0	The label is off.
	1	The label is on.

Example :DISP:WIN:LABEL ON

Set →  
 → Query

**:DISPlay:WINDow:TRACe:X[:SCALe]:OFFSet**

Description	Sets or queries the X-axis frequency offset.	
Syntax	:DISPlay:WINDow:TRACe:X[:SCALe]:OFFSet <freq>	
Query Syntax	:DISPlay:WINDow:TRACe:X[:SCALe]:OFFSet?	
Parameter	<freq>	<NRf>
Return parameter	<NR1>	Frequency in Hz.

Example :DISP:WIN:TRAC:X:OFFS 1000

Set →  
 → Query

**:DISPlay:WINDow:TRACe:Y:DLINe**

Description	Sets or queries the display line amplitude level.	
Syntax	:DISPlay:WINDow:TRACe:Y:DLINe <ampl>	
Query Syntax	:DISPlay:WINDow:TRACe:Y:DLINe?	
Parameter	<ampl>	<NRf> power or voltage in the current

		Y-axis unit.
--	--	--------------

Return parameter	<NR1>	Frequency in Hz.
------------------	-------	------------------

Example                   :DISP:WIN:TRAC:Y:DLIN -5.0e+1

Set →  
 → Query

Description	Turns the display line on/off or queries its state.	
-------------	---	--

Syntax	:DISPlay:WINDow:TRACe:Y:DLINe:STATe {OFF ON 0 1}	
--------	---	--

Query Syntax	:DISPlay:WINDow:TRACe:Y:DLINe:STATe?	
--------------	--------------------------------------	--

Parameter	0	Turns the display line off.
	1	Turns the display line on.
	OFF	Turns the display line off.
	ON	Turns the display line on.

Return parameter	0	The display line is off.
	1	The display line is on.

Example                   :DISP:WIN:TRAC:Y:DLIN:STAT ON

Set →  
 → Query

Description	Turns the on-screen scale on/off or queries its state.	
-------------	--	--

Syntax	:DISPlay:WINDow:TRACe:Y[:SCALe]:GAUge {OFF ON 0 1}	
--------	---	--

Query Syntax	:DISPlay:WINDow:TRACe:Y[:SCALe]:GAUge?	
--------------	--	--

Parameter	0	Turns the scale off.
	1	Turns the scale on.
	OFF	Turns the scale off.
	ON	Turns the scale on.

Return parameter	0	The scale is off.
	1	The scale is on.

Example :DISP:WIN:TRAC:Y:GAU ON

:DISPlay:WINDow:TRACe:Y[:SCALE]:PDIVision 
 Set →  
 Query

Description Sets or queries the Y-axis scale/div when the amplitude scale is logarithmic.

Syntax :DISPlay:WINDow:TRACe:Y[:SCALE]:PDIVision {1|2|5|10}

Query Syntax :DISPlay:WINDow:TRACe:Y[:SCALE]:PDIVision?

Parameter/	1	1 dB
Return parameter	2	2 dB
	5	5 dB
	10	10 dB

Example :DISP:WIN:TRAC:Y:PDIV ON

:DISPlay:WINDow:TRACe:Y[:SCALE]:RLEVel 
 Set →  
 Query

Description Sets or queries the Y-axis reference level. The units depend on the scale type (logarithmic/ linear).

Syntax :DISPlay:WINDow:TRACe:Y[:SCALE]:RLEVel <ampl>

Query Syntax :DISPlay:WINDow:TRACe:Y[:SCALE]:RLEVel?

Parameter/	<ampl>	<NRf>in current active unit.
Return parameter	<NR3>	Current active unit

Example :DISP:WIN:TRAC:Y:RLEV -10

:DISPlay:WINDow:TRACe:Y[:SCALe]:RLEVel (Set) →  
 :OFFSet → (Query)

Description	Sets or queries the Y-axis reference level offset.	
Syntax	:DISPlay:WINDow:TRACe:Y[:SCALe]:RLEVel:OFFSet <rel_amp>	
Query Syntax	:DISPlay:WINDow:TRACe:Y[:SCALe]:RLEVel:OFFSet?	
Parameter	<rel_amp>	<NRf>dB
Return parameter	<NR3>	
Example	:DISP:WIN:TRAC:Y:RLEV:OFFS -5.0e+1 dB	

:DISPlay:WINDow:TRACe:Y[:SCALe]:SPACing (Set) →  
→ (Query)

Description	Sets or queries the type of scale: logarithmic or linear.	
Syntax	:DISPlay:WINDow:TRACe:Y[:SCALe]:SPACing {LINear LOGarithmic}	
Query Syntax	:DISPlay:WINDow:TRACe:Y[:SCALe]:SPACing?	
Parameter/	LINear	Linear scale
Return parameter	LOGarithmic	Logarithmic scale
Example	:DISP:WIN:TRAC:Y:SPAC LOG	

## Hcopy Commands

:HCOPY:IMAGe:COLor[:STATe] .....	57
:HCOPY:IMAGe:TYPe .....	57
:HCOPY:PAGE:ORlentation .....	58
:HCOPY:PAGE:PRINts .....	58
:HCOPY:PAGE:SIZE .....	58
:HCOPY:SCReen .....	59
:HCOPY:TRACe .....	59

:HCOPY:IMAGe:COLor[:STATe] (Set) →  
→ (Query)

Description	Turns the color printing on/off or queries its state.	
Syntax	:HCOPY:IMAGe:COLor[:STATe] {OFF ON 0 1}	
Query Syntax	:HCOPY:IMAGe:COLor[:STATe]?	
Parameter	0	Turns the color printing off.
	1	Turns the color printing on.
	OFF	Turns the color printing off.
	ON	Turns the color printing on.
Return parameter	0	The color printing is off.
	1	The color printing is on.
Example	: HCOP:IMAG:COL 1	

:HCOPY:IMAGe:TYPe (Set) →  
→ (Query)

Description	Sets or queries the language for printing. The default is PCL.	
Syntax	:HCOPY:IMAGe:TYPe {PCL ESC}	
Query Syntax	:HCOPY:IMAGe:TYPe?	
Parameter/	PCL	Set the language to PCL.

Return parameter **ESC** Set the language to ESC.

Example :HCOPY:IMAG:TYP PCL

:HCOPY:PAGE:ORIENTATION

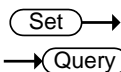

Description Sets or queries the page orientation for printing.

Syntax :HCOPY:PAGE:ORIENTATION {LANDscape|PORTRait}

Query Syntax :HCOPY:PAGE:ORIENTATION?

Parameter/ Return parameter **LANDscape** Set the page orientation to landscape.

**PORTRait** Set the page orientation to portrait.

Example : HCOP:PAGE:ORI LAND

:HCOPY:PAGE:PRINTS

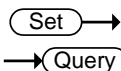

Description Sets or queries the number of print copies.

Syntax :HCOPY:PAGE:PRINTS <number>

Query Syntax :HCOPY:PAGE:PRINTS?

Parameter <number> <NR1>

Return parameter <NR1>

Example :HCOP:PAGE:PRIN 1

:HCOPY:PAGE:SIZE

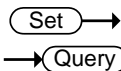

Description Sets or queries the page size for printing. The default is A4.

Syntax :HCOPY:PAGE:SIZE {DEFault|A4|A3|B5|C5|LETTer}

Query Syntax :HCOPY:PAGE:SIZE?

Parameter/	DEFault A4	Set the page size to A4.
Return parameter	A3	Set the page size to A3.
	B5	Set the page size to B5.
	C5	Set the page size to C5.
	LETTer	Set the page size to LETTer.

Example :HCOPY:PAGE:SIZE A4

**:HCOPY:SCReen**



Description Print the screen.

Syntax :HCOPY:SCReen

Example :HCOP:SCR

**:HCOPY:TRACe**



Description Print the trace.

Syntax :HCOPY:TRACe

Example :HCOP:TRAC

## Initiate Command

[:INITiate]:CONTInuous ..... 60

[:INITiate]:CONTInuous

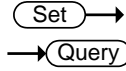

Description	Sets the sweep mode to continuous or single mode or queries its state.	
Syntax	[:INITiate]:CONTInuous {OFF ON 0 1}	
Query Syntax	[:INITiate]:CONTInuous?	
Parameter	0	Sets the sweep mode to single.
	1	Sets the sweep mode to continuous.
	OFF	Sets the sweep mode to single.
	ON	Sets the sweep mode to continuous.
Return parameter	0	The sweep mode is single.
	1	The sweep mode is continuous.
Example	:INIT:COUN ON	

## MMEMory Commands

:MMEMory:CATalog?	61
:MMEMory:COpy:SCReen	61
:MMEMory:COpy:TRACe	62
:MMEMory:DELete:ALL	62
:MMEMory:DELete:SCReen	62
:MMEMory:DELete:SCReen:ALL	62
:MMEMory:DELete:TRACe	62
:MMEMory:DELete:TRACe:ALL	63
:MMEMory:DISK:INFormation	63
:MMEMory:LOAD:SCReen	63
:MMEMory:LOAD:TRACe	63
:MMEMory:STORe:QUICK:SAVE	64
:MMEMory:STORe:SCReen	64
:MMEMory:STORe:STATe	64
:MMEMory:STORe:TRACe	64

### :MMEMory:CATalog?

→ Query

**Description** Returns a list of all the files that have been saved to the local memory.

**Query Syntax** :MMEMory:CATalog?

**Query Example** :MMEM:CAT?  
>20171010\_155852.csv,20171107\_145956.png,2017107\_150136.png,.....

### :MMEMory:COpy:SCReen

Set →

**Description** Exports the screen file to PC software.

**Syntax** :HCOpy:SCReen

**Parameter** file\_name XXX.png

Example :MMEM:COPY:SCR 20171107\_145956.png

**:MMEMory:COpy:TRACe** Set →

Description Exports the trace file to PC software.

Syntax :MMEMory:COpy:TRACe <file\_name>

Parameter **file\_name** XXX.csv

Example :MMEM:COpy:TRAC 20171010\_155852.csv

**:MMEMory:DELeTe:ALL** Set →

Description Deletes all files.

Syntax :MMEMory:DELeTe:ALL

Example :MMEM:DEL:ALL

**:MMEMory:DELeTe:SCReen** Set →

Description Deletes the selected screen file from the current directory.

Syntax :MMEMory:DELeTe:SCReen <file\_name>

Parameter **file\_name** XXX.png

Example :MMEM:DEL:SCR 20171107\_145956.png

**:MMEMory:DELeTe:SCReen:ALL** Set →

Description Deletes all screen files.

Syntax :MMEMory:DELeTe:ALL

Example :MMEM:DEL:ALL

**:MMEMory:DELeTe:TRACe** Set →

Description Deletes the selected trace file from the current directory.

Syntax	:MMEMory:DELeTe:TRACe <file_name>
Parameter	file_name XXX.csv
Example	:MMEM:DEL:TRAC 20171010_155852.csv

**:MMEMory:DELeTe:TRACe:ALL** (Set) →

Description	Deletes all trace files.
Syntax	:MMEMory:DELeTe:TRACe:ALL
Example	:MMEM:DEL:TRAC:ALL

**:MMEMory:DISK:INFormation** → (Query)

Description	Returns the information of USB storage device.
Query Syntax	:MMEMory:DISK:INFormation?
Example	:MMEM:DISK:INF?

**:MMEMory:LOAD:SCReen** (Set) →

Description	Loads screen data from a file to the internal memory.
Syntax	:MMEMory:LOAD:SCReen <file_name>
Parameter	file_name XXX.png
Example	:MMEM:LOAD:SCR 20171107_145956.png

**:MMEMory:LOAD:TRACe** (Set) →

Description	Loads trace data from a file to TRACE1.
Syntax	:MMEMory:LOAD:TRACe <file_name>
Parameter	file_name XXX.csv
Example	:MMEM:LOAD:TRAC 20171010_155852.csv

**:MMEMory:STORe:QUICK:SAVE**

**Description** Quick save the screenshot. When a USB flash drive is inserted, the image is saved into the USB flash drive, otherwise saved into the internal memory.

**Syntax** :MMEMory:STORe:QUICK:SAVE

**Example** :MMEM:STOR:QUICK:SAVE

**:MMEMory:STORe:SCREeN**

**Description** Saves the current screen-shot to the internal memory. The file is named based on date/time, the format is png.

**Syntax** :MMEMory:STORe:SCREeN <file\_name>

**Parameter** file\_name XXX.png

**Example** :MMEM:STOR:SCR 20171107\_145956.png

**:MMEMory:STORe:STATe**

**Description** Saves the instrument state as a user self-defined configuration, which is used to set the analyzer power on parameters or preset parameters.

**Syntax** :MMEMory:STORe:STATe

**Example** :MMEM:STOR:STAT

**:MMEMory:STORe:TRACe**

**Description** Saves the trace data to a file from the internal memory. The file is named based on date/time, the format is cvs.

**Syntax** :MMEMory:STORe:TRACe <file\_name>

**Parameter** file\_name XXX.csv

**Example** :MMEM:STOR:TRAC 20171010\_155852.csv

# Output Subsystem

:OUTPut:TRACk[:STATe] .....65

:OUTPut:TRACk[:STATe]

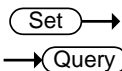

Description	Turns the tracking generator output on/off or queries its state.	
Syntax	:OUTPut:TRACk[:STATe] {OFF ON 0 1}	
Query Syntax	:OUTPut:TRACk[:STATe]?	
Parameter	0	Turns TG output off.
	1	Turns TG output on.
	OFF	Turns TG output off.
	ON	Turns TG output on.
Return parameter	0	TG output is off.
	1	TG output is on.
Example	:OUTP:TRAC ON	

## Sense Commands

---

[[:SENSe]:ACPower:BANDwidth:ACHannel:COUNT .	68
[[:SENSe]:ACPower:BANDwidth:INTEgration .....	68
[[:SENSe]:ACPower:CSPacing .....	68
[[:SENSe]:AVERage:COUNT .....	69
[[:SENSe]:AVERage[:STATe] .....	69
[[:SENSe]:BANDwidth BWIDth[:RESolution] .....	69
[[:SENSe]:BANDwidth BWIDth[:RESolution]:AUTO ..	70
[[:SENSe]:BANDwidth BWIDth[:RESolution]:STEP	
:MODE .....	70
[[:SENSe]:BANDwidth BWIDth:VIDeo .....	71
[[:SENSe]:BANDwidth BWIDth:VIDeo:AUTO .....	71
[[:SENSe]:BANDwidth:EMC .....	72
[[:SENSe]:BANDwidth:EMC:STATe .....	72
[[:SENSe]:DEMod:AM[:CARRier]:FREQuency .....	73
[[:SENSe]:DEMod:AM:IFBW .....	73
[[:SENSe]:DEMod:AM:IFBW:AUTO .....	73
[[:SENSe]:DEMod:AM:STATe .....	74
[[:SENSe]:DEMod:FM[:CARRier]:FREQuency .....	74
[[:SENSe]:DEMod:FM:IFBW .....	75
[[:SENSe]:DEMod:FM:IFBW:AUTO .....	75
[[:SENSe]:DEMod:FM:STATe .....	76
[[:SENSe]:DEMod:FREQuency .....	76
[[:SENSe]:DEMod:MODE .....	76
[[:SENSe]:DEMod:STATe .....	77
[[:SENSe]:DETEctor[:FUNCTion] .....	77
[[:SENSe]:FREQuency:CENTer .....	78
[[:SENSe]:FREQuency:CENTer:STEP:AUTO .....	78
[[:SENSe]:FREQuency:CENTer:STEP[:INCRement] ...	79
[[:SENSe]:FREQuency:REFerence .....	79
[[:SENSe]:FREQuency:SPAN .....	79
[[:SENSe]:FREQuency:SPAN:FULL .....	80
[[:SENSe]:FREQuency:SPAN:PREVious .....	80

[:SENSe]:FREQUency:SPAN:ZERO .....80  
 [:SENSe]:FREQUency:STARt .....80  
 [:SENSe]:FREQUency:STOP.....81  
 [:SENSe]:OBWidth:PERCent.....81  
 [:SENSe]:PASSFAIL:LINELimit:LOWer:CLEar .....81  
 [:SENSe]:PASSFAIL:LINELimit:LOWer:POINT<n>  
 :DElete.....81  
 [:SENSe]:PASSFAIL:LINELimit:LOWer:POINT<n>:X .82  
 [:SENSe]:PASSFAIL:LINELimit:LOWer:POINT<n>:Y .82  
 [:SENSe]:PASSFAIL:LINELimit:LOWer:STATe .....83  
 [:SENSe]:PASSFAIL:LINELimit:MARK<n>:STATe? ....83  
 [:SENSe]:PASSFAIL:LINELimit:STATe .....83  
 [:SENSe]:PASSFAIL:LINELimit:UPper:CLEar .....84  
 [:SENSe]:PASSFAIL:LINELimit:Upper:POINT<n>  
 :DElete.....84  
 [:SENSe]:PASSFAIL:LINELimit:Upper :POINT<n>:X .84  
 [:SENSe]:PASSFAIL:LINELimit:Upper :POINT<n>:Y .85  
 [:SENSe]:PASSFAIL:LINELimit:UPPer:STATe .....85  
 [:SENSe]:PASSFAIL:LINELimit:X:OFFSET .....86  
 [:SENSe]:PASSFAIL:LINELimit:Y:OFFSET .....86  
 [:SENSe]:PASSFAIL:WINDow:AMPL:LOWer.....86  
 [:SENSe]:PASSFAIL:WINDow:AMPL:UPper .....87  
 [:SENSe]:PASSFAIL:WINDow:AMPt:STATe .....87  
 [:SENSe]:PASSFAIL:WINDow:FREQUency:END .....88  
 [:SENSe]:PASSFAIL:WINDow:FREQUency:STARt .....88  
 [:SENSe]:PASSFAIL:WINDow:FREQUency:STATe.....88  
 [:SENSe]:PASSFAIL:WINDow:MARK<n> :STATe?.....89  
 [:SENSe]:PASSFAIL:WINDow:STATe.....89  
 [:SENSe]:PASSFAIL:WINDow:SWEEP:STATe.....90  
 [:SENSe]:POWer[:RF]:ATTenuation .....90  
 [:SENSe]:POWer[:RF]:ATTenuation:AUTO .....91  
 [:SENSe]:POWer[:RF]:ATTenuation:AUTO .....91  
 [:SENSe]:SWEEp:POINts .....92  
 [:SENSe]:SWEEp:TIME.....92  
 [:SENSe]:SWEEp:TIME:AUTO .....92

Set →  
 → Query

**[[:SENSe]:ACPower:BANDwidth:ACHannel:COUNT**

Description	Sets or queries the number of upper and lower adjacent channels measured by adjacent channel power.	
Syntax	[:SENSe]:ACPower:BANDwidth:ACHannel:COUNT <integer>	
Query Syntax	[:SENSe]:ACPower:BANDwidth:ACHannel:COUNT?	
Parameter/ Return parameter	<integer>	<NR1> Adjacent channels number
Example	:ACP:BAND:ACH:COUN 1	

Set →  
 → Query

**[[:SENSe]:ACPower:BANDwidth:INTEgration**

Description	Sets or queries the range of integration used in calculating the power in the main channel.	
Syntax	[:SENSe]:ACPower:BANDwidth:INTEgration <freq>	
Query Syntax	[:SENSe]:ACPower:BANDwidth:INTEgration?	
Parameter	<freq>	<NRf>
Return parameter	<NR3>	Hz
Example	:ACP:BAND:INT 2.0e+7	

Set →  
 → Query

**[[:SENSe]:ACPower:CSPacing**

Description	Sets or queries the channel spacing between the main channels.	
Syntax	[:SENSe]:ACPower:CSPacing <freq>	
Query Syntax	[:SENSe]:ACPower:CSPacing?	
Parameter	<freq>	<NRf>
Return parameter	<NR3>	Hz

Example :ACP:CSP 1.0e+8

**[[:SENSE]:AVERage:COUNT**

Set →

→ Query

**Description** Sets or queries the number of traces that are used with the average function.

**Syntax** [[:SENSE]:AVERage:COUNT <integer>

**Query Syntax** [[:SENSE]:AVERage:COUNT?

**Parameter/** <integer> <NR1>

**Return parameter**

Example :AVER:COUN 20

Set →

**[[:SENSE]:AVERage[:STATE]**

→ Query

**Description** Turns the Average function on/off or queries its state.

**Syntax** [[:SENSE]:AVERage[:STATE] {OFF|ON|0|1}

**Query Syntax** [[:SENSE]:AVERage[:STATE]?

<b>Parameter</b>	0	Turns the Average function off.
	1	Turns the Average function on.
	OFF	Turns the Average function off.
	ON	Turns the Average function on.

<b>Return parameter</b>	0	The Average function is off.
	1	The Average function is on.

Example :AVER ON

Set →

**[[:SENSE]:BANDwidth|BWIDth[:RESolution]**

→ Query

**Description** Sets or queries the resolution bandwidth (RBW).

**Syntax** [[:SENSE]:BANDwidth|BWIDth[:RESolution]<freq>

**Query Syntax** [[:SENSE]:BANDwidth|BWIDth[:RESolution]?

Parameter	<freq>	<NRf>
Return parameter	<NR3>	Hz
Example	:BAND 1.0e+6	

→  
 ←

**[[:SENSe]:BANDwidth|BWIDth[:RESolution]:AUTO**

**Description** Sets the RBW to auto (on) or manual (off) or queries its state.

**Syntax** [:SENSe]: BANDwidth|BWIDth[:RESolution]:AUTO  
**Query Syntax** {OFF|ON|0|1}  
 [:SENSe]: BANDwidth|BWIDth[:RESolution]:AUTO?

Parameter	0	Sets RBW to manual (off).
	1	Sets RBW to automatic (on).
	OFF	Sets RBW to manual (off).
	ON	Sets RBW to automatic (on).

Return parameter	0	RBW is set to manual (off).
	1	RBW is set to automatic (on).

**Example** :BAND:AUTO ON

→  
 ←

**[[:SENSe]:BANDwidth|BWIDth[:RESolution]**  
**:STEP:MODE**

**Description** Sets or queries the resolution bandwidth step mode (default or continuous).

**Syntax** [:SENSe]: BANDwidth|BWIDth[:RESolution]:  
 STEP:MODE{DEFault|CONTInuous|0|1}  
**Query Syntax** [:SENSe]: BANDwidth|BWIDth[:RESolution]:  
 STEP:MODE?

Parameter	0	Sets the resolution bandwidth step to default mode (step at 1,3,5).
	1	Sets the resolution bandwidth step to continuous mode.
	DEfault	Sets the resolution bandwidth step to default mode (step at 1,3,5).
	CONTInuous	Sets the resolution bandwidth step to continuous mode.
Return parameter	0	The resolution bandwidth step mode is default.
	1	The resolution bandwidth step mode is continuous.

Example :BAND:STEP:MODE 0

**[[:SENSE]:BANDwidth|BWIDth:VIDeo** (Set) →  
→ (Query)

Description	Sets or queries the video bandwidth (VBW).	
Syntax	[:SENSE]:BANDwidth BWIDth:VIDeo <freq>	
Query Syntax	[:SENSE]:BANDwidth BWIDth:VIDeo?	
Parameter	<freq>	<NRf>
Return parameter	<NR3>	Hz

Example :BAND:VID 1.0e+6

**[[:SENSE]:BANDwidth|BWIDth:VIDeo:AUTO** (Set) →  
→ (Query)

Description	Sets the VBW to auto (on) or manual (off) or queries its state.	
Syntax	[:SENSE]: BANDwidth BWIDth:VIDeo:AUTO {OFF ON 0 1}	
Query Syntax	[:SENSE]: BANDwidth BWIDth:VIDeo:AUTO?	
Parameter	0	Sets VBW to manual (off).
	1	Sets VBW to automatic (on).

	OFF	Sets VBW to manual (off).
	ON	Sets VBW to automatic (on).
Return parameter	0	VBW is set to manual (off).
	1	VBW is set to automatic (on).

Example :BAND:VID:AUTO OFF

**[[:SENSe]:BANDwidth:EMC**

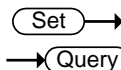

**Description** Sets the EMI filter bandwidth (must be set to the exact bandwidth).

**Syntax** [[:SENSe]:BANDwidth:EMC <freq>

**Query Syntax** [[:SENSe]:BANDwidth:EMC?

**Parameter** <freq> <NRf>  
(Only 200Hz, 9kHz, 120kHz, 1MHz are valid settings)

**Return parameter** <NR3>

Example :BAND:EMC 200

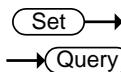

**[[:SENSe]:BANDwidth:EMC:STATe**

**Description** Turns the EMI filter on/off or queries its state.

**Syntax** [[:SENSe]:BANDwidth:EMC:STATe {OFF|ON|0|1}

**Query Syntax** [[:SENSe]:BANDwidth:EMC:STATe?

**Parameter** 0 Turns the EMI filter off.  
1 Turns the EMI filter on.  
OFF Turns the EMI filter off.  
ON Turns the EMI filter on.

**Return parameter** 0 The EMI filter is off.  
1 The EMI filter is on.

Example :BAND:EMC:STAT 0

**[[:SENSE]:DEMod:AM[:CARRier]:FREQuency** (Set) →  
→ (Query)

Description	Sets or queries the carrier frequency for AM demodulation.	
Syntax	[:SENSE]:DEMod:AM[:CARRier]:FREQuency <freq>	
Query Syntax	[:SENSE]:DEMod:AM[:CARRier]:FREQuency?	
Parameter	<freq>	<NRf>
Return parameter	<NR3>	Hz
Example	:DEM:AM:FREQ 10 mhz	

**[[:SENSE]:DEMod:AM:IFBW** (Set) →  
→ (Query)

Description	Sets or queries the IF bandwidth for AM demodulation.	
Syntax	[:SENSE]:DEMod:AM:IFBW <freq>	
Query Syntax	[:SENSE]:DEMod:AM:IFBW?	
Parameter	<freq>	<NRf>
Return parameter	<NR3>	Hz
Example	:DEM:AM:IFBW 3.0e+5	

**[[:SENSE]:DEMod:AM:IFBW:AUTO** (Set) →  
→ (Query)

Description	Sets or queries the state of auto IF bandwidth for AM demodulation.	
Syntax	:SENSE]:DEMod:AM:IFBW:AUTO {OFF ON 0 1}	
Query Syntax	:SENSE]:DEMod:AM:IFBW:AUTO?	

Parameter	0	Set IF bandwidth for AM demodulation to Manual.
	1	Set IF bandwidth for AM demodulation to Auto.
	OFF	Set IF bandwidth for AM demodulation to Manual.
	ON	Set IF bandwidth for AM demodulation to Auto.
Return parameter	0	IF bandwidth for AM demodulation is Manual.
	1	IF bandwidth for AM demodulation is Auto.

Example :DEM:AM:IFBW:AUTO 1

**[[:SENSe]:DEMod:AM:STATe**

Description	Sets or queries the state of AM demodulation.	
Syntax	SENSe]:DEMod:AM:STATe {OFF ON 0 1}	
Query Syntax	SENSe]:DEMod:AM:STATe?	
Parameter	0	Turns AM demodulation off.
	1	Turns AM demodulation on.
	OFF	Turns AM demodulation off.
	ON	Turns AM demodulation on.
Return parameter	0	AM demodulation is off.
	1	AM demodulation is on.

Example :DEM:AM:STAT 1

**[[:SENSe]:DEMod:FM[:CARRier]:FREQuency**

Description	Sets or queries the carrier frequency for FM demodulation.	
Syntax	[:SENSe]:DEMod:FM[:CARRier]:FREQuency <freq>	
Query Syntax	[:SENSe]:DEMod:FM[:CARRier]:FREQuency?	

Parameter	<freq>	<NRf>
Return parameter	<NR3>	Hz
Example	:DEM:FM:FREQ 10 mhz	

Set →  
 → Query

**[[:SENSE]:DEMod:FM:IFBW**

Description	Sets or queries the IF bandwidth for FM demodulation.	
Syntax	[:SENSE]:DEMod:FM:IFBW <freq>	
Query Syntax	[:SENSE]:DEMod:FM:IFBW?	
Parameter	<freq>	<NRf>
Return parameter	<NR3>	Hz
Example	:DEM:FM:IFBW 3.0e+5	

Set →  
 → Query

**[[:SENSE]:DEMod:FM:IFBW:AUTO**

Description	Sets or queries the state of auto IF bandwidth for FM demodulation.	
Syntax	:SENSE]:DEMod:FM:IFBW:AUTO {OFF ON 0 1}	
Query Syntax	:SENSE]:DEMod:FM:IFBW:AUTO?	
Parameter	0	Set IF bandwidth for FM demodulation to Manual.
	1	Set IF bandwidth for FM demodulation to Auto.
	OFF	Set IF bandwidth for FM demodulation to Manual.
	ON	Set IF bandwidth for FM demodulation to Auto.
Return parameter	0	IF bandwidth for FM demodulation is Manual.
	1	IF bandwidth for FM demodulation is Auto.

Example :DEM:FM:IFBW:AUTO 1

**[[:SENSe]:DEMod:FM:STATe**

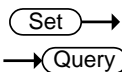

Description Sets or queries the state of FM demodulation.

Syntax SENSe]:DEMod:FM:STATe {OFF|ON|0|1}

Query Syntax SENSe]:DEMod:FM:STATe?

Parameter	0	Turns FM demodulation off.
	1	Turns FM demodulation on.
	OFF	Turns FM demodulation off.
	ON	Turns FM demodulation on.

Return parameter	0	FM demodulation is off.
	1	FM demodulation is on.

Example :DEM:FM:STAT 1

**[[:SENSe]:DEMod:FREQuency**

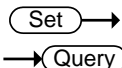

Description Sets or queries the radio frequency for the audio demodulation function.

Syntax [[:SENSe]:DEMod:FREQuency RADIO<n>,<freq>

Query Syntax [[:SENSe]:DEMod:FREQuency?

Parameter	<n>	<NR1> Radio sequence number 1 to 6.
	<freq>	<NRf>

Return parameter	<NR3>	Hz
------------------	-------	----

Example :DEM:FREQ RADIO1,87.6 mhz

**[[:SENSe]:DEMod:MODE**

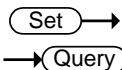

Description Sets or queries the demodulation type for the audio demodulation function.

Syntax	SENSEj:DEMod:MODE {FMW FM AM USB LSB}	
Query Syntax	SENSEj:DEMod:MODE?	
Parameter/ Return parameter	FMW	FMWdemodulation
	FM	FM demodulation
	AM	AM demodulation
	USB	USBdemodulation
	LSB	LSB demodulation

Example :DEM:MODE AM

Set →

→ Query

**[[:SENSEj]:DEMod:STATe**

Description	Turns the audio demodulation on/off or queries its state.	
Syntax	SENSEj:DEMod:STATe {OFF ON 0 1}	
Query Syntax	SENSEj:DEMod:STATe?	
Parameter	0	Turns the audio demodulation off.
	1	Turns the audio demodulation on.
	OFF	Turns the audio demodulation off.
	ON	Turns the audio demodulation on.
Return parameter	0	The audio demodulation is off.
	1	The audio demodulation is on.

Example :DEM:STAT ON

Set →

→ Query

**[[:SENSEj]:DETECTOR[:FUNCTioN]**

Description	Sets or queries the trace detection mode.	
Syntax	[:SENSEj]:DETECTOR[:FUNCTioN] {AUTO NORMAl POSitive NEGative SAMPle}	
Query Syntax	[:SENSEj]:DETECTOR[:FUNCTioN]?	
Parameter/ Return parameter	AUTO	Sets the detector mode to Auto.
	NORMAl	Sets the detector mode to Normal.
	POSitive	Sets the detector mode to Peak+.

NEGative	Sets the detector mode to Peak-.
SAMPLE	Sets the detector mode to Sample.

Example :DET NORM

**[[:SENSe]:FREQuency:CENTer**

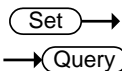

Description Sets or queries the center frequency.

Syntax [:SENSe]:FREQuency:CENTer <freq>

Query Syntax [:SENSe]:FREQuency:CENTer?

Parameter <freq> <NRf>

Return parameter <NR3> Hz

Example :FREQ:CENT 1.0e+9

**[[:SENSe]:FREQuency:CENTer:STEP:AUTO**

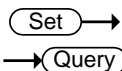

Description Sets the center frequency step size to auto (on) or manual (off) or queries its state.

Syntax [:SENSe]:FREQuency:CENTer:STEP:AUTO

Query Syntax {OFF|ON|0|1}

[:SENSe]:FREQuency:CENTer:STEP:AUTO?

0	Turn center frequency step to manual (off).
1	Turn center frequency step to auto (on).
OFF	Turn center frequency step to manual (off).
ON	Turn center frequency step to auto (on).

0	Center frequency step is set to manual.
1	Center frequency step is set to automatic.

Example :FREQ:CENT:STEP:AUTO OFF

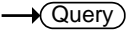
`[:SENSe]:FREQuency:CENTer:STEP[:INCRement]` 

  

Description	Sets or queries the center frequency step frequency.	
Syntax	[:SENSe]:FREQuency:CENTer:STEP[:INCRement] <freq>	
Query Syntax	[:SENSe]:FREQuency:CENTer:STEP[:INCRement]?	
Parameter	<freq>	<NRf>
Return parameter	<NR3>	Hz
Example	:FREQ:CENT:STEP 1000	

`[:SENSe]:FREQuency:REFerence` 

Description	Sets or queries the frequency reference to internal or external.	
Syntax	[:SENSe]:FREQuency:REFerence {INTernal EXTernal}	
Query Syntax	[:SENSe]:FREQuency:REFerence?	
Parameter/ Return parameter	INTernal	Internal reference
	EXTernal	External reference
Example	:FREQ:REF INT	

`[:SENSe]:FREQuency:SPAN` 

Description	Sets or queries the frequency span. Setting the span to 0 Hz puts the analyzer into zero span.	
Syntax	[:SENSe]:FREQuency:SPAN <freq>	
Query Syntax	[:SENSe]:FREQuency:SPAN?	
Parameter	<freq>	<NRf>
Return parameter	<NR3>	Hz

Example :FREQ:SPAN 1.0e+9

**[[:SENSE]:FREQUENCY:SPAN:FULL** (Set) →

Description Sets the frequency span to full scale.

Syntax [[:SENSE]:FREQUENCY:SPAN:FULL

Example :FREQ:SPAN:FULL

**[[:SENSE]:FREQUENCY:SPAN:PREVIOUS** (Set) →

Description Sets the frequency span to the previous span setting.

Syntax [[:SENSE]:FREQUENCY:SPAN:PREVIOUS

Example :FREQ:SPAN:PREV

**[[:SENSE]:FREQUENCY:SPAN:ZERO** (Set) →

Description Sets the frequency span to zero span.

Syntax [[:SENSE]:FREQUENCY:SPAN:ZERO

Example :FREQ:SPAN:ZERO

**[[:SENSE]:FREQUENCY:START** (Set) →  
→ (Query)

Description Sets or queries the start frequency.

Syntax [[:SENSE]:FREQUENCY:START <freq>

Query Syntax [[:SENSE]:FREQUENCY:START?

Parameter <freq> <NRf>

Return parameter <NR3> Hz

Example :FREQ:STAR 0

`[[:SENSE]:FREQuency:STOP` (Set) →  
→ (Query)

Description	Sets or queries the stop frequency.	
Syntax	[:SENSE]:FREQuency:STOP <freq>	
Query Syntax	[:SENSE]:FREQuency:STOP?	
Parameter	<freq>	<NRf>
Return parameter	<NR3>	Hz
Example	:FREQ:STOP 1.0e+6	

`[[:SENSE]:OBWidth:PERCent` (Set) →  
→ (Query)

Description	Sets or queries the percentage of signal power used when determining the occupied bandwidth (OBW).	
Syntax	[:SENSE]:OBWidth:PERCent <percent>	
Query Syntax	[:SENSE]:OBWidth:PERCent?	
Parameter	<percent>	<NRf>
Return parameter	<NR3>	Hz
Example	:OBW:PERC 33	

`[[:SENSE]:PASSFAIL:LINELimit:LOWer:CLEar` (Set) →

Description	Clears all points of the lower limit line.	
Syntax	[:SENSE]:PASSFAIL:LINELimit:LOWer:CLEar	
Example	:PASSFAIL:LINEL:LOW:CLE	

`[[:SENSE]:PASSFAIL:LINELimit:LOWer:POINT<n>:DELeTe` (Set) →

Description	Deletes the specified point in the lower limit line.	
-------------	--	--

Syntax [:SENSe]:PASSFAIL:LINELimit:LOWer:POINt<n>:DE  
Lete

Parameter <n> <NR1> Point number

Example :PASSFAIL:LINEL:LOW:POIN1:DEL

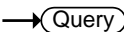
[:SENSe]:PASSFAIL:LINELimit:LOWer   
:POINt<n>:X 

Description Sets or queries the frequency limit of the  
specified point in the lower limit line.

Syntax [:SENSe]:PASSFAIL:LINELimit:LOWer:POINt<n>:X  
<freq>

Query Syntax [:SENSe]:PASSFAIL:LINELimit:LOWer:POINt<n>:X?

Parameter <n> <NR1> Point number  
<freq> <NRf> Frequency in Hz.

Return parameter <NR3> Hz

Example :PASSFAIL:LINEL:LOW:POIN1:X 2e+8

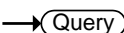
[:SENSe]:PASSFAIL:LINELimit:LOWer   
:POINt<n>:Y 

Description Sets or queries the amplitude limit of the  
specified point in the lower limit line.

Syntax [:SENSe]:PASSFAIL:LINELimit:LOWer:POINt<n>:Y  
<ampl>

Query Syntax [:SENSe]:PASSFAIL:LINELimit:LOWer:POINt<n>:Y?

Parameter <n> <NR1> Point number  
<ampl> Amplitude in dBm

Return parameter <NR3> dBm

Example :PASSFAIL:LINEL:LOW:POIN1:Y -20

`[[:SENSe]:PASSFAIL:LINELimit:LOWer:STATe` (Set) →  
→ (Query)

Description	Turns the lower limit line on/off or queries its state.	
Syntax	[:SENSe]:PASSFAIL:LINELimit:LOWer:STATe {OFF ON 0 1}	
Query Syntax	[:SENSe]:PASSFAIL:LINELimit:LOWer:STATe?	
Parameter	0	Turns the lower limit line off.
	1	Turns the lower limit line on.
	OFF	Turns the lower limit line off.
	ON	Turns the lower limit line on.
Return parameter	0	The lower limit line is off.
	1	The lower limit line is on.
Example	:PASSFAIL:LINEL:LOW:STAT 1	

`[[:SENSe]:PASSFAIL:LINELimit:MARK<n>:STATe?` → (Query)

Description	Returns the Pass/Fail judgment of limit line testing.	
Query Syntax	[:SENSe]:PASSFAIL:LINELimit:MARK<n>:STATe?	
Parameter	<n>	<NR1> Mark number
Return parameter	0	Pass
	1	Fail
Example	:PASSFAIL:LINEL:MAR1:STAT? >1	

`[[:SENSe]:PASSFAIL:LINELimit:STATe` (Set) →  
→ (Query)

Description	Turns limit line testing of pass/fail measurement function on/off.	
-------------	--	--

Syntax	SENSe]:PASSFAIL:LINELimit:STATe {OFF ON 0 1}	
Query Syntax	SENSe]:PASSFAIL:LINELimitSTATe?	
Parameter	0	Turns limit line testing off.
	1	Turns limit line testing on.
	OFF	Turns limit line testing off.
	ON	Turns limit line testing on.
Return parameter	0	Limit line testing is off.
	1	Limit line testing is on.
Example	:PASSFAIL:LINEL:STAT 1	

**[[:SENSe]:PASSFAIL:LINELimit:UPper:CLEar** Set →

Description	Clears all points of the upper limit line.	
Syntax	[:SENSe]:PASSFAIL:LINELimit:UPper:CLEar	
Example	:PASSFAIL:LINEL:UP:CLE	

**[[:SENSe]:PASSFAIL:LINELimit:Upper  
:POINT<n>:DElete** Set →

Description	Deletes the specified point in the upper limit line.	
Syntax	[:SENSe]:PASSFAIL:LINELimit:UPper:POINT<n> :DElete	
Parameter	<n>	<NR1> Point number
Example	:PASSFAIL:LINEL:UP:POIN1:DEL	

**[[:SENSe]:PASSFAIL:LINELimit:Upper  
:POINT<n>:X** Set →  
→ Query

Description	Sets or queries the frequency limit of the specified point in the upper limit line.	
Syntax	[:SENSe]:PASSFAIL:LINELimit:UPper:POINT<n>:X	

	<freq>	
Query Syntax	[:SENSe]:PASSFAIL:LINELimit:UPper:POINT<n>:X?	
Parameter	<n>	<NR1> Point number
	<freq>	<NRf> Frequency in Hz.
Return parameter	<NR3>	Hz
Example	:PASSFAIL:LINEL:UP:POINT1:X 9e+8	

[:SENSe]:PASSFAIL:LINELimit:Upper Set →  
 :POINT<n>:Y → Query

Description	Sets or queries the amplitude limit of the specified point in the upper limit line.	
Syntax	[:SENSe]:PASSFAIL:LINELimit:UPper:POINT<n>:Y <ampl>	
Query Syntax	[:SENSe]:PASSFAIL:LINELimit:UPper:POINT<n>:Y?	
Parameter	<n>	<NR1> Point number
	<ampl>	Amplitude in dBm
Return parameter	<NR3>	dBm
Example	:PASSFAIL:LINEL:UP:POINT1:Y -10	

[:SENSe]:PASSFAIL:LINELimit:UPper:STATE Set →  
→ Query

Description	Turns the upper limit line on/off or queries its state.	
Syntax	[:SENSe]:PASSFAIL:LINELimit:UPper:STATE {OFF ON 0 1}	
Query Syntax	[:SENSe]:PASSFAIL:LINELimit:UPper:STATE?	
Parameter	0	Turns the upper limit line off.
	1	Turns the upper limit line on.
	OFF	Turns the upper limit line off.
	ON	Turns the upper limit line on.

Return parameter	0	The upper limit line is off.
	1	The upper limit line is on.

Example :PASSFAIL:LINEL:UPP:STAT 1

`[[:SENSe]:PASSFAIL:LINELimit:X:OFFSET`  

Description Sets or queries the frequency offset (Shift X) of the upper and lower limit line.

Syntax `[[:SENSe]:PASSFAIL:LINELimit:X:OFFSET <freq>`

Query Syntax `[[:SENSe]:PASSFAIL:LINELimit:X:OFFSET?`

Parameter `<freq>` `<NRf>` Frequency in Hz

Return parameter `<NR3>` Hz

Example :PASSFAIL:LINEL:X:OFFSET 1.0e+6

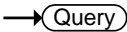
`[[:SENSe]:PASSFAIL:LINELimit:Y:OFFSET`  

Description Sets or queries the amplitude offset (Shift Y) of the upper and lower limit line.

Syntax `[[:SENSe]:PASSFAIL:LINELimit:Y:OFFSET <ampl>`

Query Syntax `[[:SENSe]:PASSFAIL:LINELimit:Y:OFFSET?`

Parameter `<ampl>` `<NRf>` Amplitude in dBm

Return parameter `<NR3>` dBm

Example :PASSFAIL:LINEL:Y:OFFSET -15

`[[:SENSe]:PASSFAIL:WINDow:AMPL:LOWer`  

Description Sets or queries the lower amplitude of amplitude line in window testing.

Syntax `[[:SENSe]:PASSFAIL:WINDow:AMPL:LOWer <ampl>`

Query Syntax `[[:SENSe]:PASSFAIL:WINDow:AMPL:LOWer?`

Parameter	<ampl>	Amplitude in dBm
Return parameter	<NR3>	dBm

Example :PASSFAIL:WIN:AMPL:LOW -20

[[:SENSE]:PASSFAIL:WINDOW:AMPL:UPper  

Description Sets or queries the upper amplitude of amplitude line in window testing.

Syntax [[:SENSE]:PASSFAIL:WINDOW:AMPL:UPper <ampl>

Query Syntax [[:SENSE]:PASSFAIL:WINDOW:AMPL:UPper?

Parameter	<ampl>	Amplitude in dBm
Return parameter	<NR3>	dBm

Example :PASSFAIL:WIN:AMPL:UP -10

[[:SENSE]:PASSFAIL:WINDOW:AMPt:STATe  

Description Turns the amplitude line of window testing on/off or queries its state.

Syntax [[:SENSE]:PASSFAIL:WINDOW:AMPt:STATe {OFF|ON|0|1}

Query Syntax SENSE]:PASSFAIL:WINDOW:AMPt:STATe?

Parameter	0	Turns the upper limit line off.
	1	Turns the upper limit line on.
	OFF	Turns the upper limit line off.
	ON	Turns the upper limit line on.

Return parameter	0	The upper limit line is off.
	1	The upper limit line is on.

Example :PASSFAIL:LINEL:UPP:STAT 1

Set →  
 → Query

**[[:SENSe]:PASSFAIL:WINDow:FREQuency:END**

Description	Sets or queries the stop frequency of frequency line in window testing.	
Syntax	[:SENSe]:PASSFAIL:WINDow:FREQuency:END<freq>	
Query Syntax	[:SENSe]:PASSFAIL:WINDow:FREQuency:END?	
Parameter	<freq>	<NRf> Frequency in Hz.
Return parameter	<NR3>	Hz
Example	:PASSFAIL:WIN:FREQ:END 8e+8	

Set →  
 → Query

**[[:SENSe]:PASSFAIL:WINDow:FREQuency:STARt**

Description	Sets or queries the start frequency of frequency line in window testing.	
Syntax	[:SENSe]:PASSFAIL:WINDow:FREQuency:STARt<freq>	
Query Syntax	[:SENSe]:PASSFAIL:WINDow:FREQuency:STARt?	
Parameter	<freq>	<NRf> Frequency in Hz.
Return parameter	<NR3>	Hz
Example	:PASSFAIL:WIN:FREQ:STAR 6e+8	

Set →  
 → Query

**[[:SENSe]:PASSFAIL:WINDow:FREQuency:STATe**

Description	Turns the frequency line of window testing on/off or queries its state.	
Syntax	[:SENSe]:PASSFAIL:WINDow:FREQuency:STATe{OFF ON 0 1}	
Query Syntax	[:SENSe]:PASSFAIL:WINDow:FREQuency:STATe?	
Parameter	0	Turns the frequency line off.
	1	Turns the frequency line on.

	OFF	Turns the frequency line off.
	ON	Turns the frequency line on.
Return parameter	0	The frequency line is off.
	1	The frequency line is on.

Example :PASSFAIL:WIN:FREQ:STAT 1

**[[:SENSe]:PASSFAIL:WINDow:MARK<n>**

**:STATe?**

→ Query

Description	Returns the Pass/Fail judgment of window testing.	
Query Syntax	[:SENSe]:PASSFAIL:WINDow:MARK<n>:STATe?	
Parameter	<n>	<NR1> Mark number
Return parameter	0	Pass
	1	Fail

Example :PASSFAIL:WIN:MAR1:STAT?  
>1

Set →

**[[:SENSe]:PASSFAIL:WINDow:STATE**

→ Query



Description	Turns window testing of pass/fail measurement function on/off.	
Syntax	[:SENSe]:PASSFAIL:WINDow:STATE {OFF ON 0 1}	
Query Syntax	[:SENSe]:PASSFAIL:WINDow:STATE?	
Parameter	0	Turns window testing off.
	1	Turns window testing on.
	OFF	Turns window testing off.
	ON	Turns window testing on.
Return parameter	0	Window testing is off.
	1	Window testing is on.

Example :PASSFAIL:WIN:STAT 1

`[:SENSe]:PASSFAIL:WINDow:SWEEP:STATe` 



Description	Turns window sweep on/off or queries its state. When the window sweep is on, only the window formed by the intersection of the amplitude line and the frequency line is swept, the peripheral stops sweeping; the full frequency is swept when it is off.	
Syntax	[:SENSe]:PASSFAIL:WINDow:SWEEP:STATe {OFF ON 0 1}	
Query Syntax	[:SENSe]:PASSFAIL:WINDow:SWEEP:STATe?	
Parameter	0 1 OFF ON	Turns window sweep off. Turns window sweep on. Turns window sweep off. Turns window sweep on.
Return parameter	0 1	Window sweep is off. Window sweep is on.
Example	:PASSFAIL:WIN:SWEEP:STAT 1	

`[:SENSe]:POWer[:RF]:ATTenuation` 

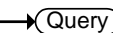

Description	Sets or queries the input attenuation.	
Syntax	[:SENSe]:POWer[:RF]:ATTenuation <rel_ampl>	
Query Syntax	[:SENSe]:POWer[:RF]:ATTenuation?	
Parameter/ Return parameter	<rel_ampl>	<NR1> 0 dB to 40 dB
Example	:POW:ATT 10 dB	

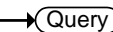
`[:SENSe]:POWer[:RF]:ATTenuation:AUTO` 

  

Description	Sets or queries whether the automatic input attenuation is on/off.	
Syntax	[:SENSe]:POWer[:RF]:ATTenuation:AUTO {OFF ON 0 1}	
Query Syntax	[:SENSe]:POWer[:RF]:ATTenuation:AUTO?	
Parameter	0	Turns automatic input attenuation off.
	1	Turns automatic input attenuation on.
	OFF	Turns automatic input attenuation off.
	ON	Turns automatic input attenuation on.
Return parameter	0	Automatic input attenuation is off.
	1	Automatic input attenuation is on.
Example	:POW:ATT:AUTO ON	

`[:SENSe]:POWer[:RF]:ATTenuation:AUTO` 

  

Description	Turns the preamplifier on/off or queries its state.	
Syntax	[:SENSe]:POWer[:RF]:GAIN[:STATe]:AUTO {OFF ON 0 1}	
Query Syntax	[:SENSe]:POWer[:RF]:GAIN[:STATe]:AUTO?	
Parameter	0	Turns the preamplifier off.
	1	Turns the preamplifier on.
	OFF	Turns the preamplifier off.
	ON	Turns the preamplifier on.
Return parameter	0	The preamplifier is off.
	1	The preamplifier is on.
Example	:POW:GAIN:AUTO ON	

**[[:SENSe]:SWEep:POINts**

Description	Sets or queries the sweep points.	
Syntax	[:SENSe]:SWEep:POINts <number>	
Query Syntax	[:SENSe]:SWEep:POINts?	
Parameter	<number>	<NR1>
Return parameter	<NR1>	
Example	:SWEep:POIN 100	

**[[:SENSe]:SWEep:TIME**

Description	Sets or queries the sweep time.	
Syntax	[:SENSe]:SWEep:TIME <time>	
Query Syntax	[:SENSe]:SWEep:TIME?	
Parameter	<time>	Sweep time in s, ms, us, ns. The default unit is ns.
Return parameter	<time>	Sweep time in millisecond.
Example	:SWE:TIME 60 ms	

**[[:SENSe]:SWEep:TIME:AUTO**

Description	Sets the Sweep time setting to auto (on) or manual (off).	
Syntax	[:SENSe]:SWEep:TIME:AUTO {OFF ON 0 1}	
Query Syntax	[:SENSe]:SWEep:TIME:AUTO?	
Parameter	0	Sets sweep time to manual (off).
	1	Sets sweep time to auto (on).
	OFF	Sets sweep time to manual (off).
	ON	Sets sweep time to auto (on).

Return parameter	0	Sweep time is set to manual.
	1	Sweep time is set to automatic.

---

Example           :SWE:TIME:AUTO 0

## Source Command

:SOURce:POWer:TRACk[:POWer] ..... 94

:SOURce:POWer:TRACk[:POWer] 

Description	Sets or queries the tracking generator output power level.	
Syntax	:SOURce:POWer:TRACk[:POWer] <ampl>	
Query Syntax	:SOURce:POWer:TRACk[:POWer]?	
Parameter	<ampl>	<NRf> Power or voltage, -30 dBm to 0 dBm
Return parameter	<NR3>	
Example	:SOUR:POW:TRAC -5	

## System Commands

:SYSTem:COMMunicate:LAN:DHCP .....	95
:SYSTem:COMMunicate:LAN:GATE .....	95
:SYSTem:COMMunicate:LAN:IP:ADDRes .....	96
:SYSTem:COMMunicate:LAN:MASK.....	96
:SYSTem:CONFIgure:FIRMWareupdate.....	96
:SYSTem:CONFIgure:information? .....	97
:SYSTem:DATE .....	97
:SYSTem:LANGuage.....	97
:SYSTem:PON:TYPE.....	98
:SYSTem:PRESet:TYPE .....	98
:SYSTem:SPEaker:VOLume.....	98
:SYSTem:Time .....	99

:SYSTem:COMMunicate:LAN:DHCP 



Description	Turns the DHCP on/off or queries its state.	
Syntax	:SYSTem:COMMunicate:LAN:DHCP {OFF ON 0 1}	
Query Syntax	:SYSTem:COMMunicate:LAN:DHCP?	
Parameter	0	Turns the DHCP off.
	1	Turns the DHCP on.
	OFF	Turns the DHCP off.
	ON	Turns the DHCP on.
Return parameter	0	The DHCP is off.
	1	The DHCP is on.
Example	:SYST:COMM:LAN:DHCP 0	

:SYSTem:COMMunicate:LAN:GATE 



Description	Sets or queries the gateway address. Gate (gateway address) should match with IP address.
-------------	---

Syntax	:SYSTem:COMMunicate:LAN:GATE <gate>	
Query Syntax	:SYSTem:COMMunicate:LAN:GATE?	
Parameter	<gate>	<String>
Return parameter	<String>	
Example	:SYST:COMM:LAN:GATE 192.168.1.1	

Set →  
 → Query

Description	Sets or queries the device IP address.	
Syntax	:SYSTem:COMMunicate:LAN:MASK <mask>	
Query Syntax	:SYSTem:COMMunicate:LAN:MASK?	
Parameter	< mask>	<String>
Return parameter	<String>	
Example	:SYST:COMM:LAN:MASK 255.255.255.0	

Set →  
 → Query

Description	Sets or queries the device subnet mask address. Mask (subnet mask address) should match with IP address.	
Syntax	:SYSTem:COMMunicate:LAN:IP:ADDRess <ip address>	
Query Syntax	:SYSTem:COMMunicate:LAN:IP:ADDRess?	
Parameter	< ip address >	<String>
Return parameter	<String>	
Example	:SYST:COMM:LAN:IP:ADDR 192.168.1.72	

Set →

Description	Updates the system with new firmware from files located on an external USB drive.	
Syntax	:SYSTem:CONFigure:FIRMwareupdate	

Example :SYST:CONF:FIRM

:SYSTem:CONFigure:information? → Query

Description Queries the system information, such as the serial number, hardware version, and temperature of the instrument.

Query Syntax :SYSTem:CONFigure:INFomation?

Return parameter	<b>&lt;String&gt;</b>	Returns the system information as a string in the following format: Serial Number = GSP XXXXXX, Hardware Version = X.X.X.X, temperature = X°C
------------------	-----------------------	--

Example :SYSTem:CONFigure:INFomation?  
>Serial Number = GSP183201, Hardware Version = 3.0.0.0, temperature = 52.50°C

Set →

:SYSTem:DATE → Query

Description Sets or queries the system date.

Syntax :SYSTem:DATE <year>,<month>,<day>

Query Syntax SYSTem:DATE?

Parameter/	<b>&lt;year&gt;</b>	<NR1> Year, an integer 2000 to 2100.
Return Parameter	<b>&lt;month&gt;</b>	<NR1> Month, an integer 1 to 12.
	<b>&lt;day&gt;</b>	<NR1> Day, an integer 1 to 31.

Query Example :SYST:DATE 2011,7,1

Set →

:SYSTem:LANGUage → Query

Description Sets or queries the language that the instrument uses to display on the screen.

Syntax :SYSTem:LANGUage {ENGLISH|CHINESE}

Query Syntax :SYSTem:LANGUage?

Parameter/	ENGLISH	The instrument displays in English.
Return Parameter	CHINese	The instrument displays in Chinese.

Query Example :SYST:LANG ENGL

:SYSTem:PON:TYPE

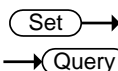

Description Sets the power-on type between user-defined and factory default.

Syntax :SYSTem:PON:TYPE {FACTory|USER}

Query Syntax :SYSTem:PON:TYPE?

Parameter/	FACTory	Factory default
Return Parameter	USER	User defined preset

Query Example :SYST:PON:TYPE USER

:SYSTem:PRESet:TYPE

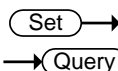

Description Sets the preset type between user-defined and factory default.

Syntax :SYSTem:PRESet:TYPE {FACTory|USER}

Query Syntax :SYSTem:PRESet:TYPE?

Parameter/	FACTory	Factory default
Return Parameter	USER	User defined preset

Query Example :SYST:PRESet:TYPE USER

:SYSTem:SPEaker:VOLume

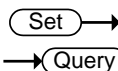

Description Sets or queries the volume setting for the demodulation function.

Syntax :SYSTem:SPEaker:VOLume <integer>

Query Syntax :SYSTem:SPEaker:VOLume?

Parameter/	<integer>	<NR1> 0 to 100
Return Parameter		

Query Example :SYST:SPE:VOL 50

:SYSTem:Time

Set →

→ Query

---

Description	Sets or queries the system time.	
Syntax	:SYSTem:TIME <hour>,<minute>,<second>	
Query Syntax	:SYSTem:TIME?	
Parameter/	<hour>	<NR1> Hour, an integer 0 to 23.
Return Parameter	<minute>	<NR1> Minute, an integer 0 to 59.
	<second>	<NR1> Second, an integer 0 to 59.
Query Example	:SYST:TIME 19,05,30	



Parameter/	<n>	<NR1> Trace number 1 to 5.
Return Parameter	WRITe	Clear and Write
	<MAXHold>	Hold the maximum points from each sweep.
	<MINHold >	Hold the minimum points from each sweep.
	< BLANK>	Clear the trace
	<VIEW>	Hold the last trace

---

Example :TRAC1:MODE VIEW

---

## Trigger Commands

:TRIGger:SEQuence:SOURce ..... 102

:TRIGger:SEQuence:SOURce:VIDeo:POWer ..... 102

:TRIGger:SEQuence:SOURce (Set) →  
→ (Query)

Description	Sets or queries the triggering source.	
Syntax	:TRIGger:SEQuence:SOURce {RUN VIDeo POSitive NEGative}	
Query Syntax	:TRIGger:SEQuence:SOURce?	
Parameter/ Return parameter	RUN	Run trigger
	VIDeo	Video trigger
	POSitive	Positive trigger
	NEGative	Negative trigger
Example	:TRIG:SEQ:SOUR RUN	

:TRIGger:SEQuence:SOURce:VIDeo:POWer (Set) →  
→ (Query)

Description	Sets or queries the video trigger power.	
Syntax	:TRIGger:SEQuence:SOURce:VIDeo:POWer <ampl>	
Query Syntax	:TRIGger:SEQuence:SOURce:VIDeo:POWer?	
Parameter	<ampl>	<NRf> power
Return parameter	<NR3>	
Example	:TRIG:SEQ:SOUR:VID:POW 10	

## UDISK Commands

:UDISK:STOR:SCReen.....	103
:UDISK:STOR:TRACe .....	103

### :UDISK:STOR:SCReen

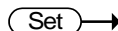

Description	Saves the current screen-shot to a folder named "spectrum" (created automatically) in USB storage device, the file is named based on date/time, the format is png.
-------------	--

Syntax	:UDISK:STOR:SCReen
--------	--------------------

Example	:UDIS:STOR:SCR
---------	----------------

### :UDISK:STOR:TRACe



Description	Saves the trace data to a folder named "spectrum" (created automatically) in USB storage device, the file is named based on date/time, the format is cvs.
-------------	---

Syntax	:UDISK:STOR:TRACe
--------	-------------------

Example	:UDIS:STOR:TRAC
---------	-----------------

## UNIT Command

:UNIT:POWer..... 104

:UNIT:POWer

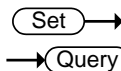

Description	Sets the amplitude unit.	
Syntax	:UNIT:POWer {DBM DBUW DBPW DBMV DBUV W V}	
Query Syntax	:UNIT:POWer?	
Parameter/ Return parameter	DBM	Decibels
	DBUW	Decibels relative to one microwatt
	DBPW	Decibels relative to one picowatt
	DBMV	Decibels relative to one millivolt
	DBUV	Decibels relative to one microvolt
	W	Watt
	V	Volt
Example	:UNIT:POW DBM	